

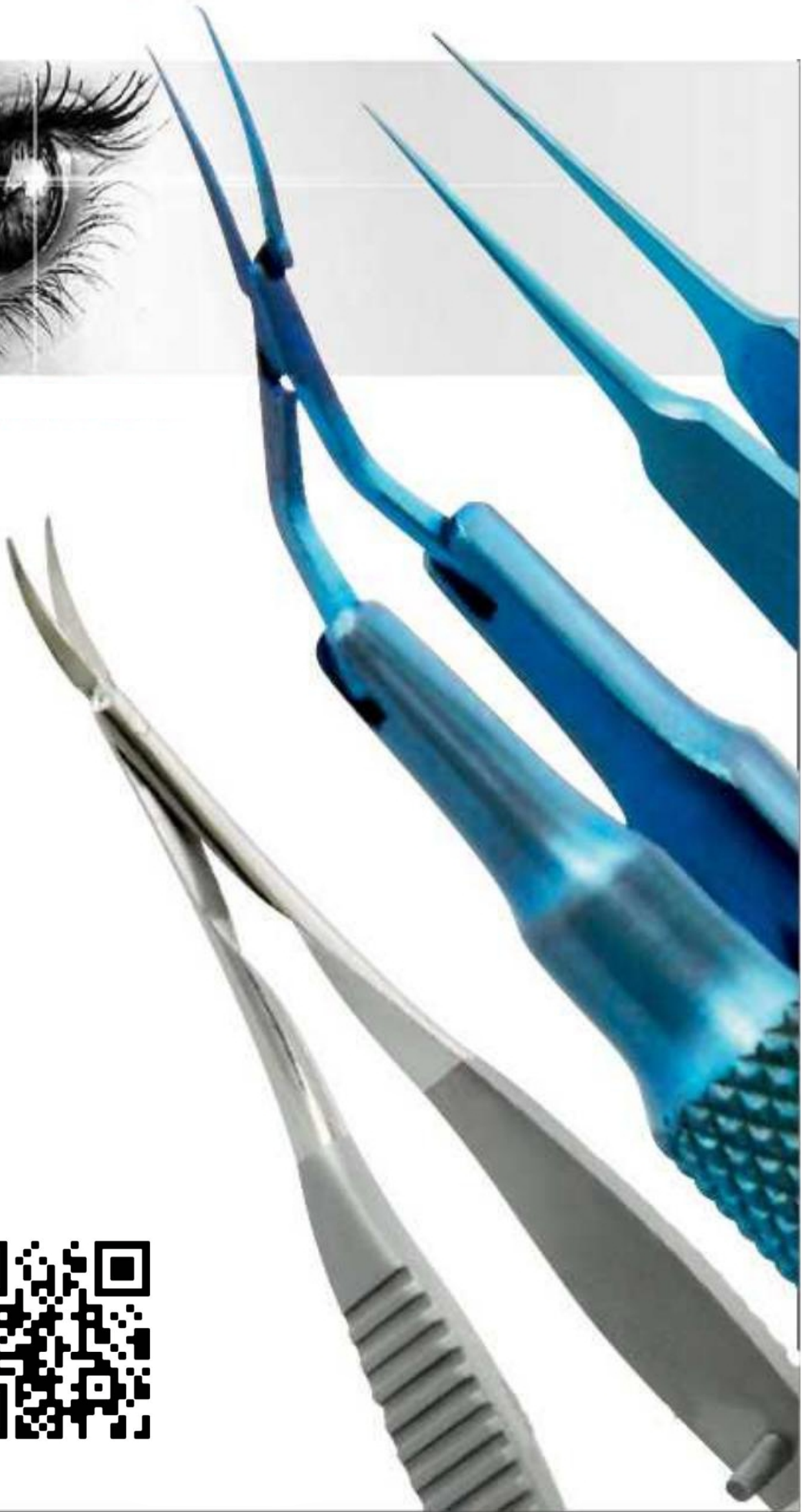

LOTUSMED
INSTRUMENTS



Ophthalmic Catalogue



Barraquer

Wire Speculum

- LT-001** standard wire, 10mm blades
- LT-002** extra heavy wire, 15mm blades
- LT-003** heavy wire, 15mm blades
- LT-004** standard wire, 15mm blades
- LT-005** infant size, 9mm blades

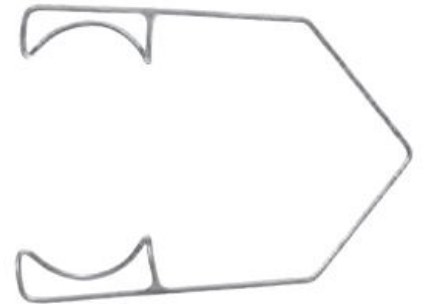

Grandon-Barraquer

Wire Speculum

with suture notches

Used to obtain additional traction for the upper eyelid.

- LT-006** 15mm blades

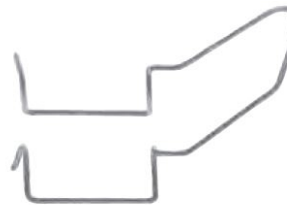
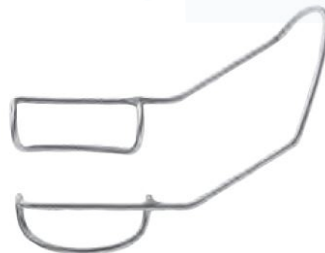
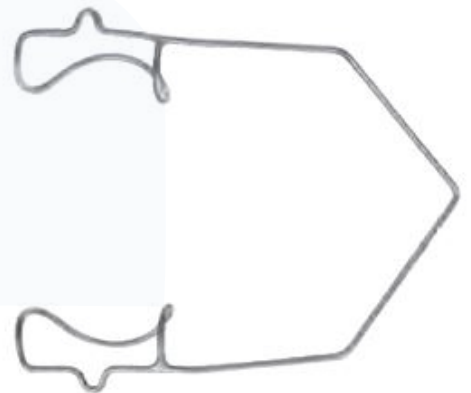

Temporal-Approach

Wire Speculum

with spring on nasal side

- LT-007** 15mm closed blades
- LT-008** 15mm open blades
- LT-009** 15mm solid blades

Solid Blade

Wire Speculum

- LT-010** Barraquer, 10mm blades
- LT-011** Barraquer, 15mm blades
- LT-012** Barraquer, 15mm blades



Kratz-Barraquer

Wire Speculum

15mm blades
one solid and one open wire

- LT-013** for right eye
- LT-014** for left eye

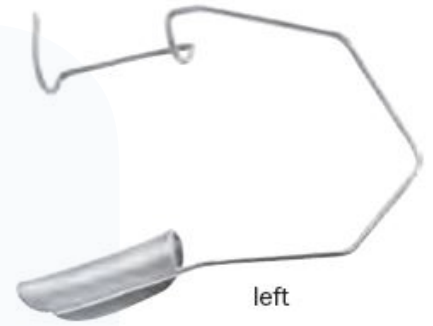
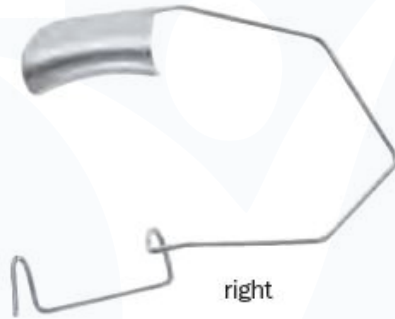

Kratz-Barraquer

Wire Speculum

with open blades

For unobstructed access to the cataract incision with phaco or I/A tip.

- LT-015** heavy wire, 15mm blades (not shown)
- LT-016** standard wire, 15mm blades
- LT-017** standard wire, 13mm blades

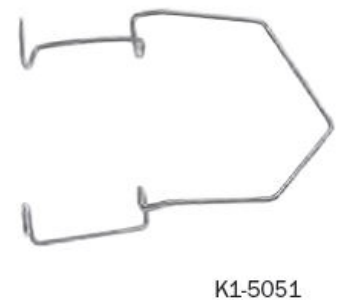
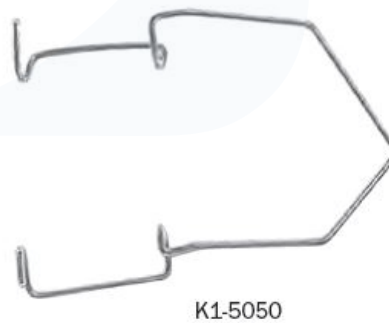

Kratz-Barraquer

Wire Speculum

with wings

For retracting the lids
up and away from the globe
to eliminate external pressure.

LT-018 15mm blades

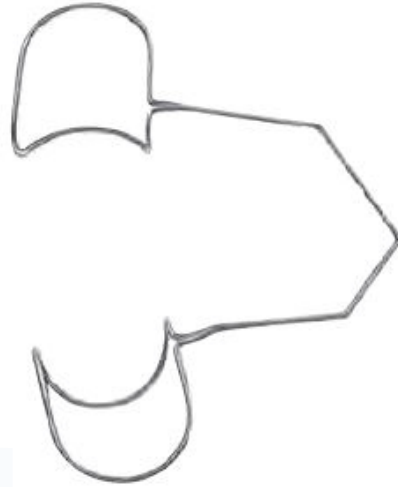

McIntyre

Wire Speculum

gently curved springs

V-shaped blades are designed to
retain surgical drape under the eyelids

LT-019 closed wire, 13mm blades

LT-020 Open wire, 13mm blades

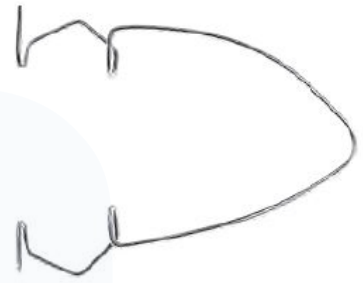

Nevyas

Wire Speculum

Designed to retain surgical drape under the
eyelids while allowing unobstructed access to the
cataract incision with phaco or I/A tip

LT-021 16mm blades

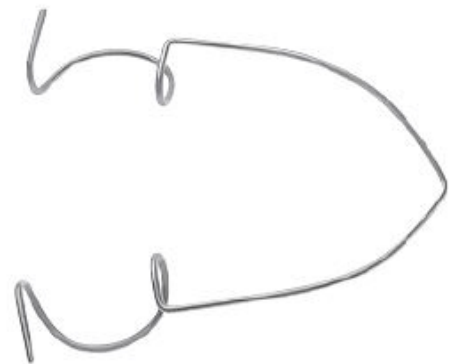

Lieberman Style, aspirating

adjustable mechanism

Features aspirating ports to remove excess fluid from the surgical field.

Supplied with silicone tubing and luer-lock adaptor.

- LT-022** Lieberman, Kratz style, 15mm blades
- LT-023** Thorlakson, rounded, 11mm blades
- LT-024** Lieberman, V-shaped, 15mm blades
- LT-025** Chu, solid, reversible, 15mm blades
- LT-026** replacement silicone tubing, 100cm (39")



K1-5171

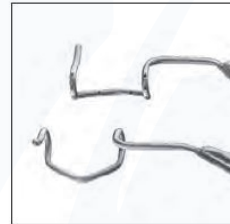
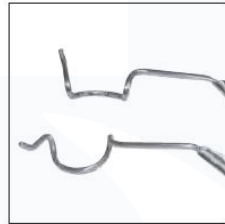

Double-X

Aspirating Speculum
adjustable, Kratz style
15mm blades

LT-027



Sauer

Lid Speculum

LT-028 for infants, 11mm blades

LT-029 for premature infants, 2mm blades



Frankel

Infant Lid Speculum
adjustable

For precise control of
infant eyelid retraction.

LT-030 10mm blades



Infant

Wire Speculum

interlacing 3mm & 5mm blades
For use with newborns or infants

LT-031

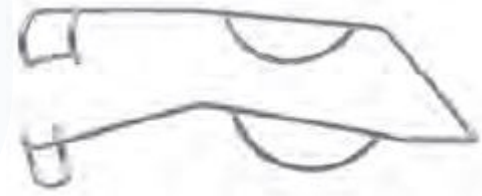

Alphonso

Infant Lid Speculum

finger grips and interlacing blades
to facilitate insertion
one blade 5mm, one blade 7mm

LT-032

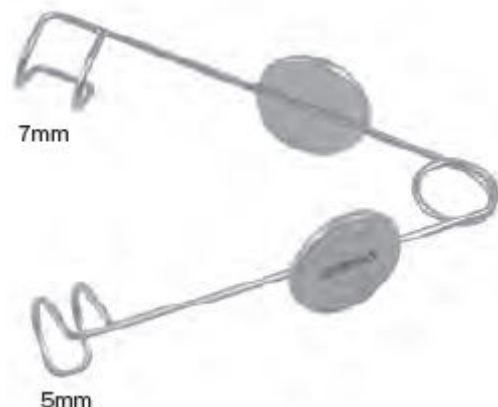

Infant

Lid Speculum
closed wire blades
gently curved spring
LT-033 4mm blades

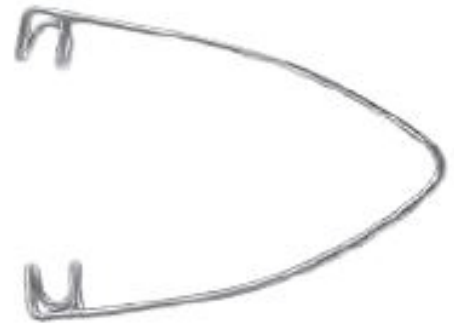

Femto

Lid Speculum
flat 15mm wire blades
with locking screw
LT-034



Cook

Eye Speculum
with locking screw
LT-035 #1, 8mm blades
LT-036 #2, 11mm blades
LT-037 #3, 15mm blades (not shown)



Murdoch

Eye Speculum
with locking screw

- LT-038** #2, 12mm blades
- LT-039** #3, 15mm blades



Mellinger

Eye Speculum
self retaining
For unobstructed access to the
cataract incision with phaco or I/A tip.

- LT-040** 15mm blades



Williams

Eye Speculum
with locking screw

LT-041 11mm blades

LT-042 15mm blades



Lancaster

Eye Speculum
adjustable mechanism
with locking nut

LT-043 16mm blades



Lester-Burch

Eye Speculum
with flanges on blades for
retaining eye lashes
adjustable mechanism
with locking screw

LT-044



Lieberman Speculums

- LT-045** Lieberman, infant K-wire, 5mm
- LT-046** Lieberman, infant solid blade, 5mm
- LT-047** Tanna-Lieberman, 15mm blades with traction suture anchor posts
- LT-048** Lieberman, K-wire, 10mm blades, small
- LT-049** Lieberman, K-wire, 15mm blades, standard
- LT-050** Seltzer, flattened K-wire, 15mm blades
- LT-051** Thorlakson, rounded, 11mm blades
- LT-052** Lieberman, triple post, 13mm blades
- LT-053** Lieberman, V-shaped, 15mm blades
- LT-054** Lieberman, solid blades, 10mm blades (*not shown*)
- LT-055** Lieberman, solid blades, 15mm blades
- LT-056** Ginsberg, flared upper blades, fenestrated lower blades, 15mm blades



K1-5671

5mm blades

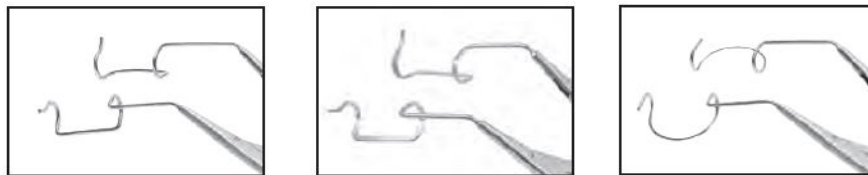

Reversible

Eye Speculum

adjustable mechanism

non-reflective finish

Designed for nasal or temporal placement.

LT-057 15mm blades



Lieberman

Temporal Approach Speculum

Kratz style open wire blades

adjustable mechanism on nasal side

LT-058 15mm blades



Lieberman

Temporal Approach Speculum

V-wire blades

adjustable mechanism on nasal side

LT-059 15mm blades



Meyerhoefer

Chalazion Curette

- LT-060** size 0, 1.5mm dia.
- LT-061** size 1, 1.75mm dia.
- LT-062** size 2, 2.25mm dia.
- LT-063** size 3, 2.5mm dia.
- LT-064** size 4, 3.5mm dia.

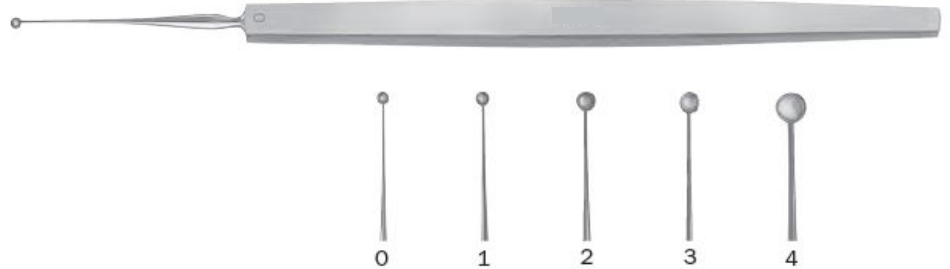

Capsule

Polishing Curette

1.75mm diameter open ring

LT-065 Nightingale,
semi-sharp,
posterior edge

LT-066 Shepherd,
semi-sharp
anterior and posterior
edges



Scorsetti-Shepherd

Capsule Polisher

1.75mm diameter open ring

tip angled 90°

semi-sharp

anterior and posterior edges

LT-067



Anis

Capsule Scrubber

flexible wire

textured disc

LT-068



Blumenthal

Conjunctiva Dissector
with blunt disc shaped tip

LT-069

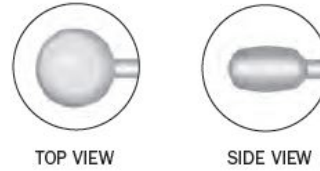

Buratto

LASIK Flap Protector
For retracting and
protecting nasally hinged
corneal flaps.

LT-070



Mannis-Buratto

LASIK Flap Protector
blades angled 45°
For retracting and protecting
superiorly hinged corneal flaps.

LT-071



Rowen

Combination LASIK Flap
Protector and Spatula
LT-072



Camellin Style

LASEK Alcohol Well
*For retaining alcohol solution
on the corneal epithelium.*

LT-073 8.5mm diameter
LT-074 9.5mm diamete



BOTTOM VIEW



Endothelial Stripper

1mm wide, thin beveled tip

LT-075 smooth surface

LT-076 Rosenwasser
with textured surface

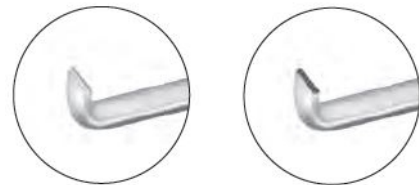

Sloane

LASEK Micro Hoe
semi-circular tip with
beveled edge
For lifting the precut margin
of the epithelial flap.

LT-077



Sloane

LASEK Epi Peeler
semi-sharp edges
For peeling and folding back
the epithelial flap.

LT-078



Sloane

LASEK Micro Hoe &
Epi Peeler

LT-079



Sloane

LASEK Flap Repositor
gently curved spatulated tip
with beveled smooth edges
For repositing and smoothing
the epithelial flap after laser
ablation.

LT-080



DALK

Corneal Dissector

LT-081 12mm long,
flattened, vaulted
spatula with beveled tip

LT-082 Rosenwasser
DALK Trisector
with triangular shaft and
spatulated tip

LT-083 Bonfadini DALK
Spatula 1mm wide, 8mm long,
flattened spatula
with central groove for
bisecting stroma

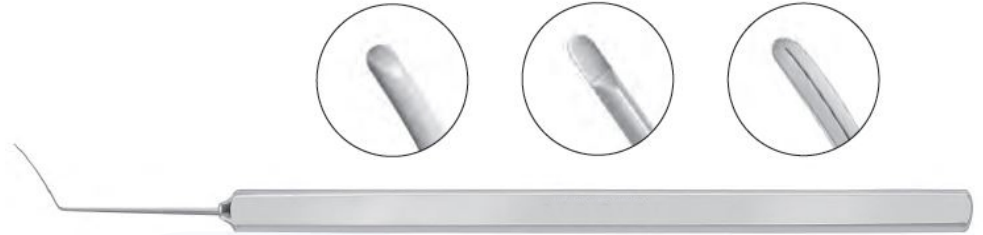

Rootman-Goldich

DMEK Dissector

semi-circular tip
with beveled edge

For atraumatic donor
preparation during
DMEK procedures.

LT-084



Culler

Iris Spatula

LT-085 1mm wide

LT-086 2mm wide



Wheeler

Double-End Spatula
lightly curved
LT-087



Barraquer

Iris Spatula
round, smooth
LT-088 0.5mm diameter
LT-089 0.25mm diameter



ZKS

Iris Spatula
2mm wide x 8mm long
0.2mm thick
LT-090



Gimbel

Nucleus Spatula
round, smooth
angled 30° at
10mm from the tip
0.25mm diameter
LT-091



Alio-Scimitar

MICS Phaco Pre-chopper
curved with blunt tip and
sharp inferior edge
For bimanual nucleus pre-
chopping.
LT-092



Phaco Chopper

ball tip
0.7mm inferior wedge
LT-094



Nagahara

Phaco Chopper
rounded, blunt tip
0.9mm inferior wedge
LT-095 (shown)
LT-096 short handle, 100mm



Anis

Phaco Chopper
rounded, blunt, olive tip
offset inferior wedge
LT-097 for use in right hand
LT-098 for use in left hand

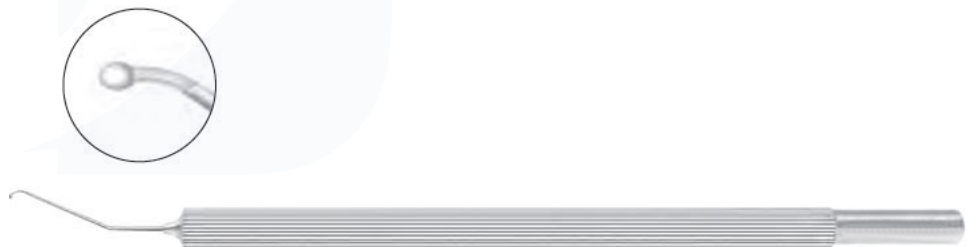

Chang-Seibel

Phaco Chopper
a combination chopper with the
Chang MicroFinger and the
Seibel Vertical Safety Chopper
LT-099 for use in right hand
LT-100 for use in left hand

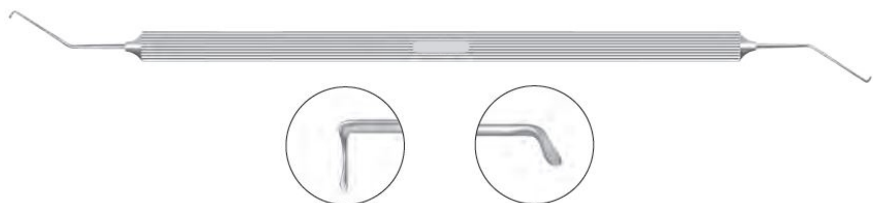

Milder

Phaco Chopper
60° offset inferior wedge
for horizontal chopping and
a beveled distal tip for
vertical chopping

LT-101 for use in left
hand

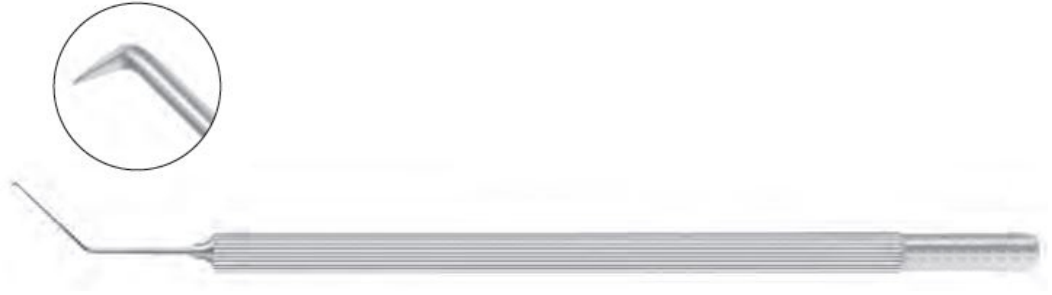

Milder

Phaco Chopper, double-end
60° offset inferior wedge for
horizontal chopping and a
beveled
distal tip for vertical chopping.
A 12mm long spatula with a
disc-shaped tip is on the
opposite end.

LT-102 for use in the right
hand

LT-103 for use in the left
hand

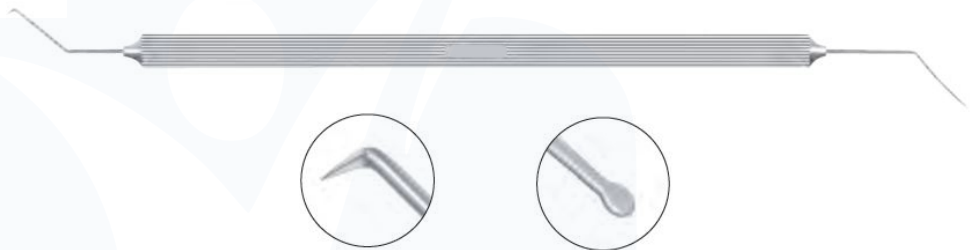

Escaf

Nucleus Manipulator
flattened olive-shaped tip
angled at 45°

LT-104



Knolle

Nucleus Spatula
malleable stainless steel, flat
0.5mm wide

LT-105



Koch-Nagahara

Karate Chopper
60° offset 1mm cutting wedge
for horizontal chopping and
pointed tip for vertical
chopping.

A gently curved duckbill
shaped
spatula is on the opposite
end.

LT-106 for use in right hand

LT-107 for use in left
hand



Koch

Nucleus Spatula
gently curved duckbill
shaped tip

LT-108 smooth

LT-109 with notches



Akahoshi

Nucleus Sustainer
*Designed to provide
counterpressure when
used with the
Akahoshi PreChopper.*

LT-110



Escaf

Nucleus Sustainer
smooth ball tip
textured inferior surface
LT-111



Lieberman

MicroFinger
Nucleus Manipulator
LT-112 for use in right
hand
LT-113 for use in left
hand



Lieberman

MicroFinger and Spatula
LT-114 for use in right
hand
LT-115 for use in left
hand



Fukasaku-Lieberman

Phaco Spatula
a combination of the
small pupil snapper hook
and the MicroFinger
LT-116 for use in
right hand
LT-117 for use in
left hand



Masket

Phaco Spatula
a combination of the Rosen
Phaco Splitter and a 12mm
long round spatula with disc
shaped tip
LT-118



Chang

Phaco Chopper
a combination of a modified
MicroFinger and a 0.9mm long
"Quick Chop" tip
LT-119 for use
in right hand
LT-120 for use in left hand



Minardi

Phaco Chopper
0.7mm long
"Quick Chop" tip
LT-121



Hwang

Phaco Chopper
1mm long
vertical chopper
and a chisel
tipped spatula
LT-122



Agarwal

Karate Phaco Chopper
semi-sharp, wedge shaped
inferior edge with a
pointed tip

LT-123



Warren

Canine Phaco Chopper
a combination of a 3.5mm
long MicroFinger and a
2mm
long pointed "Quick Chop
" tip

For veterinary use only.

LT-124



Brierley

Nucleus Splitter
1.0mm long tip, angled
with incisi
on sealing shaft

LT-125



Chang

MicroFinger Chopper
curved finger shaped tip
*With defined inner edge
for horizontal chopping.*

LT-126



Dodick-Kammann

Nucleus Chopper

For bimanual nucleus division.

LT-127 1.5mm long tip,
straight

LT-128 1.5mm long tip,
angled

LT-129 2mm long tip,
straight

LT-130 2mm long tip,
angled

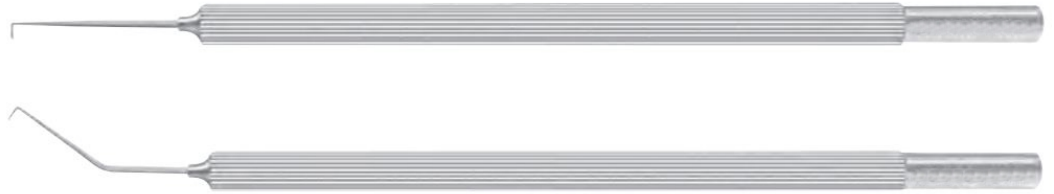

Koch

Nucleus Chopper

1.6mm long with blunted tip

With rounded surfaces designed for safely splitting and dividing a very soft nucleus.

LT-131



Escaf

Nucleus Divider

1.25mm long
wedge shaped tip
For vertical chopping.

LT-132



Neuhann

Nucleus Divider

strongly curved
spatulated tip

LT-133



Nagahara

Nucleus Spatula
flat inferior edge
LT-134

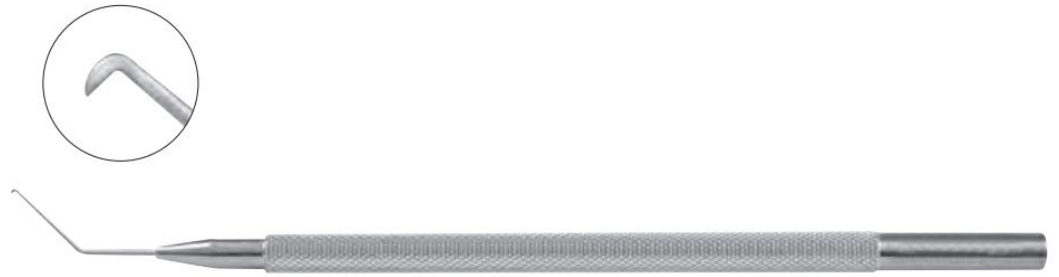

Fukasaku

wedge shaped inferior
edge

LT-135 Snapper Hook

LT-136 Small Pupil

Snapper Hook with
notch to engage
the iris



Rosen

Phaco Splitter
wedge-shaped inferior
edge blunt tip

LT-137 inline wedge,
standard

LT-138 60° offset
wedge, for
use in left hand



Rowen

Phaco Spatula
a combination of the
Rosen Phaco Splitter
and the Bechert
Nucleus Rotator
LT-139



Bechert

Nucleus Rotator
blunt forked tip

LT-140 angled at 7mm

LT-141 angled at 9mm

(not shown)

LT-142 short handle



Clayman

Nucleus Rotator
0.5mm wide flat spatula
with V-notched tip

LT-143



Grayson

Nucleus Manipulator
flattened, smoothly polished
1.1mm long
with "tear-drop" shaped tip

LT-144



Drysdale

Nucleus Manipulator
paddle shaped tip

LT-145 rounded edges

LT-146 defined

anterior edge

for capsule polishing



Pisacano

Nucleus Rotator

flat disc shaped tip

LT-147 horizontal

LT-148 vertical



Siepsier

Endocapsular Controller

trumpet shaped tip

LT-149



Anis

Nucleus Manipulator

with 0.5mm diameter ball tip

LT-150 straight

KT3-151 straight, titanium

LT-152 angled (shown)

LT-153 angled, titanium



Tennant

Nucleus Rotator

with 0.6mm diameter

ball shaped tip

LT-154



Lippman

Nucleus Spatula
0.5mm diameter round
shaft with blunt forked tip
LT-155



Donnenfeld

Femto Spatula
1mm long x 0.3mm wide
flattened tip
LT-156 pointed
LT-157 blunt

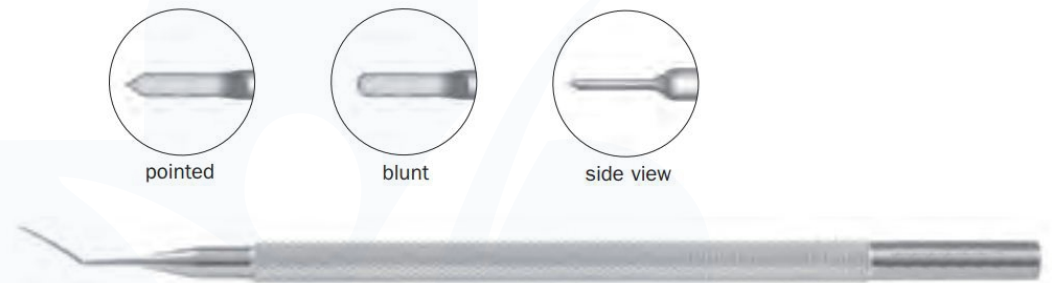

Donnenfeld

Femto Splitter
paracentral curve in shaft
LT-158 right (shown)
LT-159 left



ZKS

Femto Spatula
double-ended with blunt tips
1mm long x 0.3mm wide
flattened spatula and
2mm wide keratome-
shaped tip
LT-160



Girard

Synechiaie Spatula
0.5mm wide with
semi-sharp tip
LT-161



Obstbaum

Synechiaie Spatula
0.25mm wide with
semi-sharp tip
LT-162



Benedetto

IntraLase®Spatula
10mm long, smoothly
polished flattened spatula
with beveled notches
LT-163

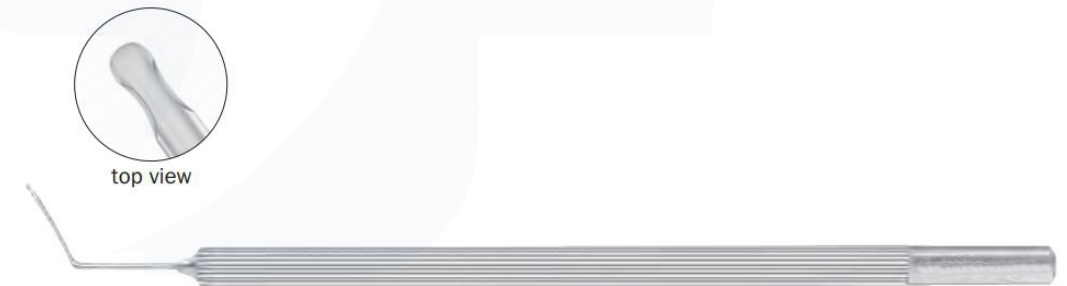

Moran

LASIK Enhancement
Spatula
Fukasaku spatula
and a modified Paton
spatula
LT-164



Hersh

IntraLase® Flap Spatula
beveled tips
a combination of a
6mm spatula and
a 10mm spatula
LT-165



Binder

IntraLase® Flap Elevator
1mm wide
12mm long
semi-sharp edges
LT-166



Fukasaku

LASIK Spatula
rounded anterior and
flat posterior surface
with beveled tip
For lifting and dissecting
the corneal flap.
LT-167



Guimaraes

LASIK Spatula
gently curved, bi-convex
semi-sharp edges
LT-168



Katzen

LASIK Flap “Unzipper”
combines a modified
Sinskey Hook and
a bi-convex spatula with
beveled notches
For LASIK enhancements.
LT-169



Maddox

LASIK Spatula
combines a flat spatula and
a cylindrical spatula
For elevating and
repositing the flap.
LT-170



Thorlakson

Z-LASIK™ Flap Lifter
combines a modified
Sinskey Hook
and a bi-convex spatula
with beveled notches
LT-171 long handle
LT-172 short handle



LASIK Flap Lifter

Combines a 45° angled
Sinskey Hook
and a thin hook with
a conical tip
LT-173
LT-174 titanium



SMILE Spatula

Combination instrument for opening the incision and dissecting the pocket during SMILE procedures.

LT-175

(use K5-7550 for removing lenticule)

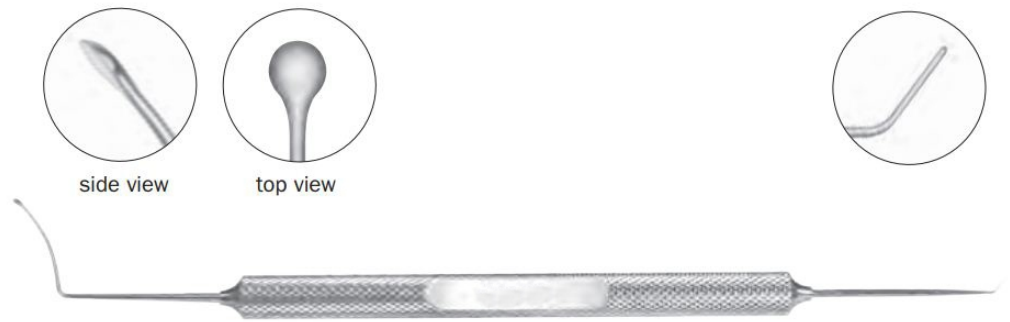

Hirschman

Lens Spatula
flat 0.5mm wide
with multiple notches

LT-176



Jaffe

Lens Spatula
flat, 0.5mm wide

LT-177



Labor

IOL Manipulator
short handle
For use with intra-operative
aberrometry systems.

LT-178



Lester

IOL Manipulator
0.25mm diameter tip
Ideal for multi-directional
manipulation.

LT-2680 straight,
with guard

LT-179 angled

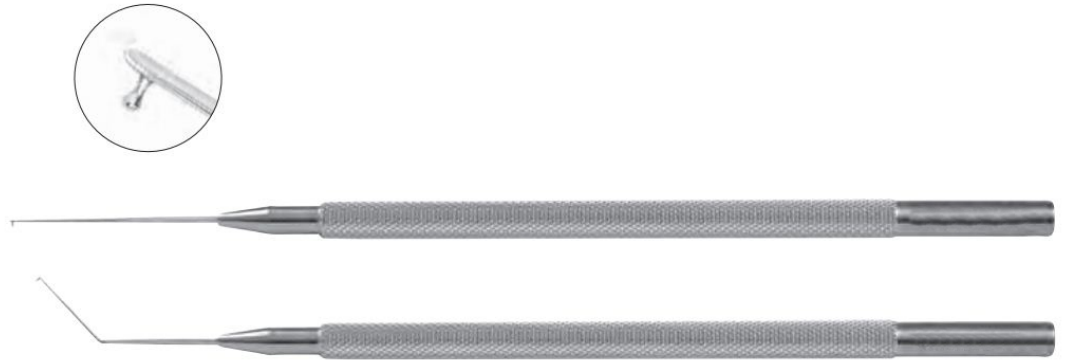

Lester

IOL Manipulator
0.25mm diameter tip
vaulted shank
For engaging the inferior
haptic
without touching the dome
of the IOL.

LT-180



Maloney

IOL Manipulator
0.25mm diameter tip
vaulted shank
with guard

LT-181



Hunkeler

IOL Manipulator
with 0.3mm diameter
hemi-ball tip, vaulted shank

LT-182



Alio-Kelman

IOL Hook
0.2mm diameter tip
LT-183



Aker

Lens Pusher
smooth, fish mouth
shaped tip
with guard
LT-184



Bechert

Lens Pusher
vertical Y-shaped tip
angled
LT-185
(for horizontal version see
LT-186)



Elschnig

Cyclodialysis Spatula
flat, 1mm wide
LT-187



Castroviejo

Synechiaie Spatula

0.5mm wide with
semi-sharp tips

LT-188



Castroviejo

Cyclodialysis Spatula

LT-189 0.25mm wide

LT-190 0.5mm wide



Labor

Cyclodialysis Spatula

slightly vaulted

0.5mm wide, angled 5mm

For use with intra-operative
aberrometry

LT-191



Kimura

Platinum Spatula

LT-192



Keener

Lens Divider
with three
preformed
snare wire loops
LT-193 complete
LT-194 wire loops (pk/3)



Lens Loop

LT-195 Lewis, small
LT-196 Lewis, large
LT-197 New Orleans
LT-198 Wilder, serrated



K3-4000

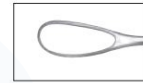

K3-4030



K3-4100



Kirby

Lens Loop and
Muscle Hook
LT-199



Morrison

Lens Loop and Probe
LT-200



Lens Loop

serrated, 3mm wide

LT-201 Kansas,
light curve

LT-202 Keener-Arlt,
strong curve



Alfonso

Nucleus Trisector

1.5mm wide

(used with **LT-203**
Alfonso Cutting Platform)

For manual small incision surgery.

LT-204



Bucher-Kansas

Nucleus Trisector

2.5mm wide

(used with **LT-205**
Alfonso Cutting Platform)

LT-206



Kansas

Nucleus Trisector

4mm wide

(used with **LT-207**
Kansas Vectis)

LT-208



Kansas
Nucleus Bisector
LT-209



Kansas
Nucleus Vectis
Used as a cutting block for
nucleus bisector or trisector.
LT-210



Alfonso
Cutting Platform
Used as a cutting block for
nucleus trisector.
*For manual small incision
surgery.*
LT-211 2mm wide
(used with LT-4145)
LT-212 3mm wide
(used with
LT-213



Culler
Lens Spoon
sterling silver
LT-214



Paton

Spatula & Spoon
For corneal button
transfer.

LT-215



Rosenwasser

Lamella Donor Shovel
with retaining rim on 3 sides
For atraumatic insertion
of the donor lamella.
wide

LT-216 5mm



Endothelial Glide

funnel-shaped spatula
cut-out notch at tip
(used with LT-7550)

LT-217

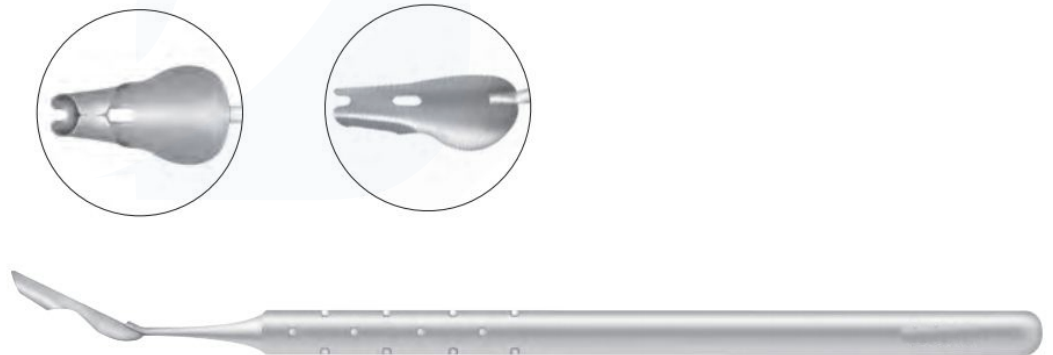

Bunge

Evisceration Spoon
small
large

LT-218

LT-219



Wells

Enucleation
Spoon
LT-220



Graether

Collar Button
micro iris retractor
LT-221 straight,
with guard
LT-222 angled



Graether

Irrigating Collar Button
micro iris retractor and
posterior capsule polisher
LT-223 straight
LT-224 angled



Castroviejo

Corneoscleral Scissors
small blades

LT-225 right (shown)

LT-226 left



Castroviejo

Corneoscleral Scissors
medium blades

LT-227 right (shown)

LT-228 left



Troutman-Castroviejo

Corneoscleral Scissors
with stop, small blades

LT-229 right (shown)

LT-230 left



Troutman-Castroviejo

Corneoscleral Scissors
with stop, medium blades

LT-231 right

LT-232 left (shown)



Troutman-Katzin

Corneal Transplant Scissors
with stop

strong curve, small blades

LT-233 right

LT-234 left (shown)



Rich

Corneal Transplant Scissors
extremely delicate,
strongly curved blades

For trimming the recipient corneal
bed and donor button.

Can also be used for open sky
anterior capsulotomy.

LT-235 right

LT-236 left (shown)



Terry

Micro Corneal Scissors
round handle
for meticulous control
LT-237 right (shown)
LT-238 left



Holland

DALK Scissors
spatulated tip
LT-239 right (shown)
LT-240 left



Katzin

Corneal Transplant Scissors
strong curve, medium blades
LT-241 right
LT-242 left (shown)



Castroviejo

Universal Corneal Scissors
curved, blunt tips

LT-243 small blades

LT-244 medium blades

LT-245 large blades

LT-246 strongly curved
large blades



Castroviejo

Keratoplasty Scissors

angled to side

blunt tips, medium blades

LT-247



McPherson-Westcott

Conjunctival Scissors

curved

blunt tips, small blades

LT-248



Sarkisian-Westcott

Scissors
small blades
with nine 1mm landmarks
laser etched on one blade
*For intra-operative cutting and
measuring with a single
instrument.*

LT-249

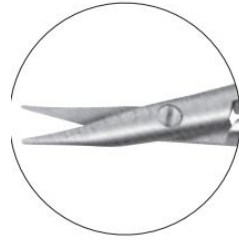

Westcott

Tenotomy Scissors
blunt tips, medium blades
curved

LT-250

Westcott

Tenotomy Scissors
blunt tips, standard blades
curved

LT-251 right (shown)

LT-252 left



Tibolt

Punctal Scissors
one conically shaped blade
with micro grooves and
textured surface
For simple "Two-snip
Punctoplasty".

LT-253



Mini Westcott

Tenotomy Scissors
4mm long curved blades
blunt tips

LT-254



McPherson-Westcott

Stitch Scissors
very sharp pointed tips
small blades
curved

LT-255



Westcott

Stitch Scissors
very sharp pointed tips
standard blades
curved
LT-256



Jaffe

Stitch Scissors
very sharp pointed tips
medium blades
curved
LT-257



Micro Tying Scissors
For tying and cutting
9-0 to 11-0 sutures.
2.75mm long tying platform
Not to be used as a
needle driver.
LT-258



side view



Iris

Scissors
sharp tips, small blades
LT-259 straight
LT-260 curved



K4-4410



Fine

Stitch Scissors
sharp tips, medium blades
LT-261 straight
LT-262 curved



K4-4510



Barraquer

Iris Scissors
blunt tips, 7mm long blades
LT-263



Capsulotomy Scissors

Vannas

5mm long blades, sharp tips

LT-264 straight

LT-265 curved

LT-266 angled forward

LT-267 angled to side

Gills-Vannas

7mm long blades, sharp tips

LT-268 straight

LT-269 curved

LT-270 angled forward

Holland DALK Scissors

4.5mm angled blades

LT-271 blunted tips

McPherson-Vannas

8mm long blades, sharp tips

LT-272 curved



Capsulotomy Scissors

Katena-Vannas

7mm extra thin long blades,
sharp tips

ZKS-273 -Vannas, straight

LT-274 -Vannas, curved

LT-275 Gills-Vannas, angled
forward

10mm extra thin long blades,
sharp tips

ZKS-276 -Vannas, straight

ZKS-277 -Vannas, curved

LT-278 Stern-Gills, angled
forward

LT-279 Uribe-Stern, curved,
angled, forward

10mm long angled blades,
curved tips

LT-280 Gills, sharp points

LT-281 Uthoff-Gills, blunt points

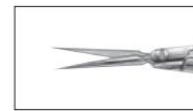

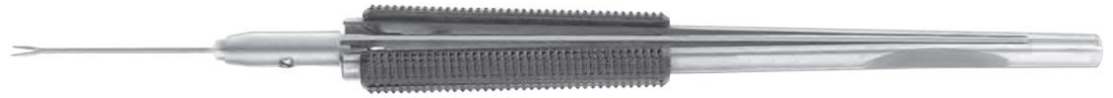

Vitrectomy

Scissors
20 gauge shank
Stainless steel
construction with
serrated plastic handle.
Autoclavable
LT-282



“Squeeze Handle” Scissors
These “squeeze handle”
instruments feature titanium
handles to reduce overall
weight, and front ends
of hardened stainless steel
for secure cutting
LT-283



Botvin

Iris Forceps
For peripheral iridectomies.
LT-284 serrated tips
LT-285 1x2 teeth



Gills-Colibri

Tissue Forceps
very fine pointed tips
with tying platform
LT-286



Colibri Style

Tissue Forceps
very delicate, 1x2 teeth,
0.12mm

LT-287 Colibri
LT-288 Harms-Colibri, with
tying platform
LT-289 Harms-Colibri,
titanium, with tying
platform

LT-290 Dyson-Colibri, short
tips, extremely
thin shanks, with tying platform
Standard, 1x2 teeth with tying
platform

LT-291 Colibri, 0.4mm
Corneal Suturing Forceps
very delicate, 1mm spread, 1x2
teeth, 0.12mm

LT-292 Polack
Corneal Forceps
very delicate, 1x1 teeth, 0.1mm
LT-293 Pierse-Colibri



Hofmann-Polack

Corneal Suturing Forceps
with guide pin
1mm spread
1x1 teeth, 0.2mm
LT-294



Hoskin

Tissue Forceps, curved
LT-495 #16, fine
grooved tips



Hoskin

Tissue Forceps, straight
LT-296 #18, fine grooved tips
LT-297 #19, micro grooved tips
LT-298 #28, very
delicate, micro grooved
tips



Hoskin

Tissue Forceps, Colibri style

LT-299 #22, micro grooved tips

LT-300 #30, very delicate micro grooved tips

LT-301 #34, pointed tips



K5-1722



K5-1730



K5-1734



Pierse

Corneal Forceps
very delicate
1x1 teeth, 0.1mm
straight

LT-302



Fechtner

Conjunctiva Forceps
very delicate
ring shaped tips
with tying platform

LT-303

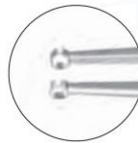

Castroviejo-Colibri

Forceps
very delicate
1x2 teeth, 0.12mm

LT-304



Harms-Colibri

Forceps
very delicate
1x2 teeth, 0.12mm
with tying platform
LT-305



Hyde

Corneal Forceps
2x2 teeth, 0.12mm
with tying platform
LT-306



Bonn

Forceps
very delicate
1x2 teeth, 0.12mm
LT-307



Bonn

Forceps
1x2 teeth, 0.12mm
with tying platform
LT-308 stainless steel
LT-309 titanium



Thorpe

Corneal Forceps
2x3 teeth, 0.12mm
with tying platform
LT-310



McPherson

Tissue Forceps
1x2 teeth, 0.4mm
with tying platform
LT-311 straight
LT-312 angled



Kelman-McPherson

Forceps
8mm long jaws
1x2 teeth, 0.3mm
LT-313



Hoffer-McPherson

Forceps
very delicate
11mm long jaws
1x2 teeth, 0.12mm
LT-314



Castroviejo

Suturing Forceps
1x2 teeth
with tying platform

- LT-315** 0.12mm
- LT-316** 0.3mm
- LT-317** 0.5mm
- LT-318** 0.9mm
- LT-219** 0.12mm, titanium



Snider-Castroviejo

Suturing Forceps
with guide pin
1x2 teeth, 0.12mm
with tying platform

LT-320



Stern-Castroviejo

Fixation Forceps
1x2 teeth, 0.5mm
with lock

LT-321



Moody

Fixation Forceps
1x2 teeth, 0.5mm
with lock

- LT-322** left (not shown)
- LT-323** right



Helveston

Fixation Forceps
1x2 teeth, 0.6mm
For globe fixation
during strabismus
procedures.

LT-324



Girard

Corneoscleral Forceps
1x2 teeth, 0.12mm
with tying platform

LT-325 for use in right hand

LT-326 for use in left hand



Perl

Corneal Forceps
1x2, 0.08mm teeth
For atraumatic grasping
and fixation of tissue.

LT-327 for use in right hand

LT-328 for use in left hand



Maumenee-Colibri

Corneal Forceps
very delicate
1x2 teeth, 0.12mm

LT-329



Bishop-Harmon

Tissue Forceps

1x2 teeth

LT-330 delicate

LT-331 standard (not shown)

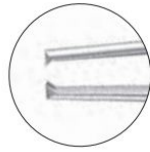

Bishop-Harmon

Dressing Forceps

criss-cross serrated tips

LT-332



Fixation Forceps

1x2 teeth, 0.3mm

LT-333 Sauer

LT-334 Manhattan Eye & Ear,
with tying platform



Dressing Forceps

serrated, delicate

LT-335 straight

LT-336 curved



Tissue Forceps

1x2 teeth

LT-337 delicate, straight

LT-338 delicate, curved
(not shown)

LT-339 standard, straight
(not shown)



Adson

straight, 5" (125mm) long

LT-340 Dressing Forceps
serrated jaws,
delicate

LT-341 Dressing Forceps
serrated jaws,
standard

LT-342 Tissue Forceps
1x2 teeth, delicate

LT-343 Tissue Forceps,
1x2 teeth, standard

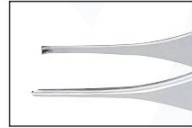
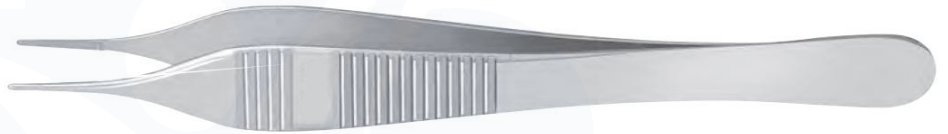

Bayonet

Dressing Forceps

serrated jaws

5 3/4" (146mm) long

LT-344



Lester

Fixation Forceps

straight

LT-345 1x2 teeth

LT-346 2x3 teeth
(not shown)



Fixation Forceps

1x2 teeth

LT-347 Bracken,
delicate teeth

LT-348 Elschmig,
standard teeth
(not shown)



Troutman

Superior Rectus
Forceps

1x2 teeth
angled

LT-349



Tying Forceps

For 8-0 to 11-0 sutures.

McPherson

5mm long smooth jaws

LT-350 straight

LT-351 straight, titanium

LT-352 angled

LT-353 angled, titanium

Kelman-McPherson

7.5mm long smooth jaws

LT-354 angled

LT-355 angled, titanium

Bechert

10mm long smooth jaws

LT-356 angled

Gaskin

11mm long smooth jaws

LT-357 angled

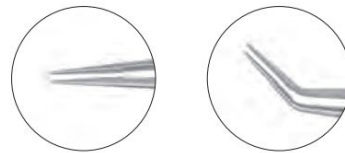

Haberle-McPherson

Lens Holding Forceps
7.5mm long jaws
with groove, angled
For grasping IOL haptic.
LT-358



Kurstin

Flap Stretching Forceps
disc shaped
serrated jaws
Designed for stretching
the flap to eliminate striae.
LT-359



Buratto

LASIK Flap Forceps
disc shaped
serrated jaws
LT-360



Mendez

Multi-Purpose
LASIK Forceps
spatulated jaws and tips
smooth grasping surfaces
vaulted shanks
For lifting, dissecting and
grasping the corneal flap.
LT-361



Inamura

Capsulorrhexis Forceps
delicate tapered shanks
to seal the incision during
continuous curvilinear
capsulorrhexis
Excellent for MICS.
LT-362



Utrata

Capsulorrhexis Forceps
very delicate, short handle
triangular grasping tips
extremely thin with landmarks
at 2.5mm and 5.0mm
LT-363 straight



Masket

Capsulorrhexis Forceps
very delicate, short handle
triangular grasping tips
extremely thin with landmarks
at 2.5mm and 5.0mm
LT-364 vaulted



Kraff

Capsule Tag Forceps
11mm long shanks
1.5mm long grasping tips
LT-365



Utrata

Capsulorrhexis Forceps

very delicate

triangular grasping tips

extremely thin

11mm long shanks

LT-366 stainless steel

LT-367 titanium

Also available for MICS, see

LT-368.



Utrata

Capsulorrhexis Forceps

very delicate

triangular grasping tips

extremely thin

11mm long shanks

round handle with guide pin

for alignment

LT-369



Nevyas

Capsulorrhexis Forceps

cystotome shaped tips

extremely thin

11mm long shanks

For tearing and grasping

the anterior capsule.

LT-370

Also available for MICS, see

LT-271



Masket

Capsulorrhexis Forceps

very delicate

triangular grasping tips

extremely thin 11mm long

vaulted shanks

LT-372



Masket

Capsulorrhexis Forceps

very delicate

triangular grasping tips

extremely thin 11mm long

vaulted shanks

round handle with guide pin
for alignment

LT-373



Jaffe

Capsulorrhexis Forceps

very delicate

round grasping tips

extremely thin

11mm long shanks

LT-374



Giannetti

MICS Capsulorrhexis Forceps

ultra delicate shanks and tips

maximum jaw opening 1.75mm

For performing capsulorrhexis
through a micro incision.

LT-375

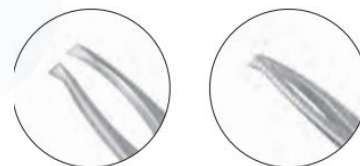

Utrata

MICS Capsulorrhexis Forceps

very delicate

triangular grasping tips

thin 11mm shanks

maximum jaw opening 1.75mm

For performing capsulorrhexis
through a micro incision.

LT-376



Giannetti

MICS Capsulorrhexis Forceps
ultra-delicate shanks and tips
maximum jaw opening of 1.75mm
flat handle

For performing capsulorrhexis
through a micro incision.

LT-377



Neyyas

MICS Capsulorrhexis Forceps
cystotome shaped tips
ultra-delicate shanks and tips
maximum jaw opening of
1.75mm
flat handle

*For penetrating and grasping
the anterior
capsule while performing a
capsulorrhexis
through a micro incision.*

LT-378



Florakis

Endothelial Forceps
extra-delicate, reversed
triangular tips angled 75°
To aid in the removal of
endothelium

from the host cornea.

LT-379



Sinskey

Tying Forceps
very delicate
smooth jaws

For 8-0 to 11-0 sutures.

LT-380 straight

LT-381 curved (not shown)



Anis

Tying Forceps
extra delicate
smooth jaws

For 9-0 to 11-0 sutures.

LT-382 straight (not shown)

LT-383 curved



Freeman-Jaffe

Lens Holding Forceps
with longitudinal groove
For grasping IOL haptic.

LT-384



Jaffe

Tying Forceps
very delicate
smooth jaws

6mm long platform

For 8-0 to 11-0 sutures.

LT-385 straight

LT-386 curved



Gerl

Tying Forceps
curved shanks

6mm long platform

For 8-0 to 11-0 sutures.

titanium

LT-387



Tennant

Tying Forceps
extra delicate smooth jaws
with 6mm long platform
round handle with guide pin
For 9-0 to 11-0 sutures.

- LT-388** straight
- LT-389** straight, titanium
- LT-390** curved
- LT-391** curved, titanium

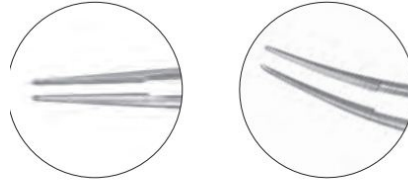

Maumenee

Tying Forceps
concave-convex jaws
round handle with guide pin
For 8-0 to 11-0 sutures.

- LT-392** straight
- LT-393** angled



JAWS CROSS SECTION



Harms

Tying Forceps
standard, smooth jaws
for 7-0 to 9-0 sutures.

- LT-394** straight
- LT-395** curved

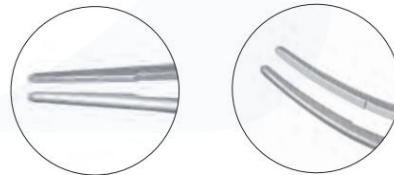

Helveston

Tying Forceps
standard, smooth jaws
For 4-0 to 6

- LT-396**



Fine

Tying Forceps
standard, smooth jaws
For 7-0 to 9-0 sutures.
LT-397



Fine

Tying Forceps
standard, smooth jaws
For 7-0 to 9-0 sutures.
LT-398



Barraquer

Cilia Forceps
lightly angled
Textured jaws provide superior grasping capabilities.
LT-399



Cilia Forceps
slanted jaws
gold plated
LT-400

Gradle

Cilia Forceps
smooth jaws
LT-401



Bonaccolto

Conjunctiva Forceps
longitudinally serrated jaws
with cross serrations at tips

LT-402 1.2mm wide

LT-403 1.7mm wide
(not shown)



Nugent

Utility Forceps
LT-6214 smooth jaws (not
shown)

LT-404 serrated jaws



Gold

Punctal Plug Forceps
0.2mm wide longitudinal
groove inside jaws
pointed tips

LT-405



Foreign

Body Forceps
straight

LT-406



Utility & Splinter

Forceps
pointed, short jaws
Suitable for epilation.
LT-407 #H



Jewelers

Forceps
standard, straight
LT-408 #1



Jewelers

Forceps
delicate, straight
LT-409 #3-C



Jewelers

Forceps
delicate, straight
LT-410 #



Jewelers

Forceps
delicate, straight
LT-411 #



Jewelers

Forceps
extra delicate, straight
LT-412 #5



Jewelers

Forceps
extra delicate, angled
LT-413 #5/45



Jewelers

Forceps
curved
LT-414 #7



Suture

Removal Forceps
very fine pointed tips
with textured jaws
Ideal for grasping wet sutures.
LT-415



Jaffe

Utility Forceps
very delicate smooth jaws
curved
LT-416



Arruga

Capsule Forceps
LT-417



Akahoshi

Phaco PreChopper
4.5mm long delicate jaws
with sharp tips
For cracking, dividing and rotating
the nucleus without sculpting.
LT-418



Akahoshi

Combo PreChopper
For cracking, dividing and rotating
both hard and soft nuclei without
sculpting.
LT-419



Wright

Nucleus Cracker
extra delicate cross-action
serrated paddle tips

LT-420 For cracking the
nucleus
through a 2.5mm incision.

LT-421 For cracking the
nucleus
through a 2mm incision.



Dodick

Nucleus Cracker
cross-action
longitudinally serrated
paddle shaped jaws
For cracking the nucleus
through a 3mm incision.

LT-422



Hu

Femto Forceps
blunted 0.3mm tips
cross-action mechanism
For opening incisions
created with a
femtosecond laser.

LT-423



Alfonso

Nucleus Grasping Forceps
two short rows of
delicate interlocking teeth
For grasping and extracting
nucleus fragments.

LT-424



Femto

Nucleus Forceps
22 gauge
flattened textured tips
angled at 90°
reverse action
For removing a complete cap,
finishing a rhexis and
splitting nucleus fragments.

LT-425



Vitreo-Retinal Forceps

stainless steel with
serrated plastic handle
autoclavable

LT-426



smooth jaws
20 gauge, straight
LT-7500

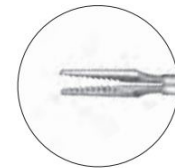

serrated jaws
20 gauge, straight
LT-751

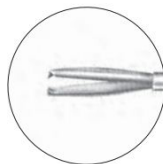

serrated jaws
20 gauge, straight
LT-751

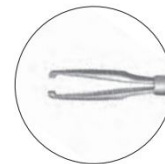

smooth jaws
end gripping
20 gauge, straight
LT-7530



smooth jaws
20 gauge, vertical
LT-7540

McPherson

Needle Holder

very delicate jaws

LT-427 straight jaws,
with lock

LT-428 straight jaws,
without lock

LT-429 curved jaws, with lock

LT-430 curved jaws,
without lock



Jaffe

Needle Holder

delicate conical jaws

LT-431 straight, with lock

LT-432 curved, with lock

LT-433 curved, without
lock



Castroviejo

Needle Holder

delicate jaws

LT-434 straight, with lock

LT-435 straight, without
lock

LT-436 curved, with lock

LT-437 curved, without lock



Castroviejo

Needle Holder
standard jaws
straight, with lock
LT-438



Castroviejo

Needle Holder
standard jaws
curved, with lock
LT-439



Kalt

Needle Holder
delicate smooth jaws
straight, with lock
LT-440



Drews

Needle Holder

extra delicate jaws

LT-441 straight, with lock

LT-442 straight, without lock

LT-443 curved, with lock

LT-444 curved, without lock



Barraquer

Needle Holder

short model

very delicate jaws

straight

LT-445 with lock

LT-446 without lock

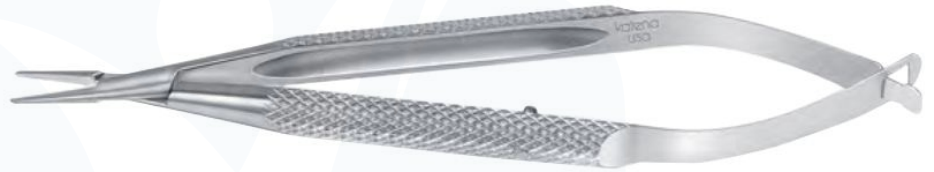

Barraquer

Needle Holder

short model

very delicate jaws

curved

LT-447 with lock

LT-448 without lock



Troutman

Needle Holder

delicate jaws

strongly curved

LT-449 without lock

LT-450 with lock



Barraquer

Needle Holder
very delicate jaws
curved

LT-451 with lock

LT-452 without lock

LT-453 titanium, with lock

LT-454 titanium, without lock



Barraquer

Needle Holder
delicate jaws
straight

LT-455 with lock

LT-456 without lock



Barraquer

Needle Holder
delicate jaws
curved

LT-457 with lock

LT-458 without lock



Barraquer

Needle Holder
standard jaws
curved

LT-459 with lock

LT-460 without lock



Anis

Needle Holder
extra delicate jaws
straight

LT-461 with lock

LT-462 without lock



Anis

Needle Holder
extra delicate jaws
curved

LT-463 with lock

LT-464 without lock





EXTRA CAPSULAR CATARACT EXTRACTION USING PHACOEMULSIFICATION SET

- | | | | |
|------------|--------------------------------------|------------|--------------------------------------|
| 1. LT-465 | Bishop-Harmon A/C Irrigator | 23. LT-487 | Tennant Tying Forceps, curved |
| 2. LT-466 | Double-X Speculum, V-Wire, 15mm | 24. LT-488 | Utrata Capsulorrhexis Forceps |
| 3. LT-467 | Temporal Speculum, open wire | 25. LT-489 | Kelman-McPherson Forceps, angled |
| 4. LT-468 | Diamond Knife, tri-facet | 26. LT-490 | Ernest-McDonald IOL Insertor |
| 5. LT-469 | Phaco-4 Diamond Knife, 2.8mm, angled | 27. LT-491 | Livernois IOL Folder |
| 6. LT-470 | Chuck Handle | 28. LT-492 | Katena Needle Holder, curved, w/lock |
| 7. LT-471 | Super Sharp Blade, 15 deg. (bx) | 29. LT-493 | Ernest Nucleus Cracker |
| 8. LT-472 | Hartmann Mosquito Forceps, str. | 30. LT-494 | Iris Retractors, (set 6) in case |
| 9. LT-473 | Jones Towel Clamp | 31. LT-495 | Simcoe I/A Cannula, curved |
| 10. LT-474 | Chang Combination Chopper, left | 32. LT-496 | McIntyre-Binkhorst Cannula, right |
| 11. LT-475 | Chang Hydrodissection Cannula, 27ga. | 33. LT-497 | McIntyre-Binkhorst Cannula, left |
| 12. LT-476 | Rosen Phaco Splitter | 34. LT-498 | Hydrodissection Cannula, 25ga. |
| 13. LT-477 | Kuglen Iris Hook, angled | 35. LT-499 | Air Injection Cannula, 27ga. |
| 14. LT-478 | Jaffe-Bechert Rotator, 9mm | 36. LT-500 | Jensen Polisher, 23ga. |
| 15. LT-479 | Lester IOL Manipulator, angled | 37. LT-501 | Stevens Sub-Tenon's Cannula, 19ga. |
| 16. LT-480 | Westcott Tenotomy Scissors | 38. LT-502 | Fine-Thornton Fixation Ring, 13mm |
| 17. LT-481 | Castroviejo Caliper, straight | 39. LT-503 | Bipolar Forceps, angled, blunt |
| 18. LT-482 | Stern-Gills Scissors | 40. LT-504 | Bipolar Cord |
| 19. LT-483 | Colibri Forceps, 0.12mm teeth | 41. LT-505 | McIntyre Reverse Cystotome |
| 20. LT-484 | Castroviejo Forceps, 0.12mm | 42. LT-506 | Vannas Scissors, curved |
| 21. LT-485 | Fechtner Conjunctiva Forceps | 43. LT-507 | K-Sponge Spears |
| 22. LT-486 | Tennant Tying Forceps, straight | 44. LT-508 | Sterilizing Case, double, aluminum |

*not shown



PHACO PRECHOP SET

1. LT-509 Double-X Speculum, 13mm blades
2. LT-510 Iris Retractors (set 6) in case
3. LT-511 Ernest Micro Nucleus Cracker
4. LT-512 Sinskey II Lens Manipulator
5. LT-513 Jaffe-Bechert Nucleus Rotator
6. LT-514 Dodick-Kammann Chopper 1.5mm, angled (x2)
7. LT-515 Aspiration Handpiece, 21ga. w/ textured tip
8. LT-516 Irrigation Handpiece, 21ga. dual 0.5mm sideports
9. LT-517 Phaco-4 Diamond Knife, 2.8mm, angled
10. LT-518 Diamond Knife, tri-facet, 1mm
11. LT-519 Air Injection Cannula, 30ga.
12. LT-520 Kratz Scratcher, 22ga.

13. LT-521 Kuglen Hook, angled
14. LT-522 Utrata MICS Capsulorhexis Forceps
15. LT-523 Castroviejo Caliper, straight
16. LT-524 Westcott Tenotomy Scissors
17. LT-525 Westcott Stitch Scissors
18. LT-526 Sauter Hydrodissection Cannula, 27ga.
19. LT-527 Hydrodissection Cannula, 25ga.
20. LT-528 Cystotome, formed, 25ga. (bx/10)
21. LT-529 Akahoshi Phaco PreChopper
22. LT-530 Akahoshi Combo PreChopper
23. LT-531 Akahoshi Nucleus Sustainer
24. LT-532 Instrument Case, large, aluminum
* not shown

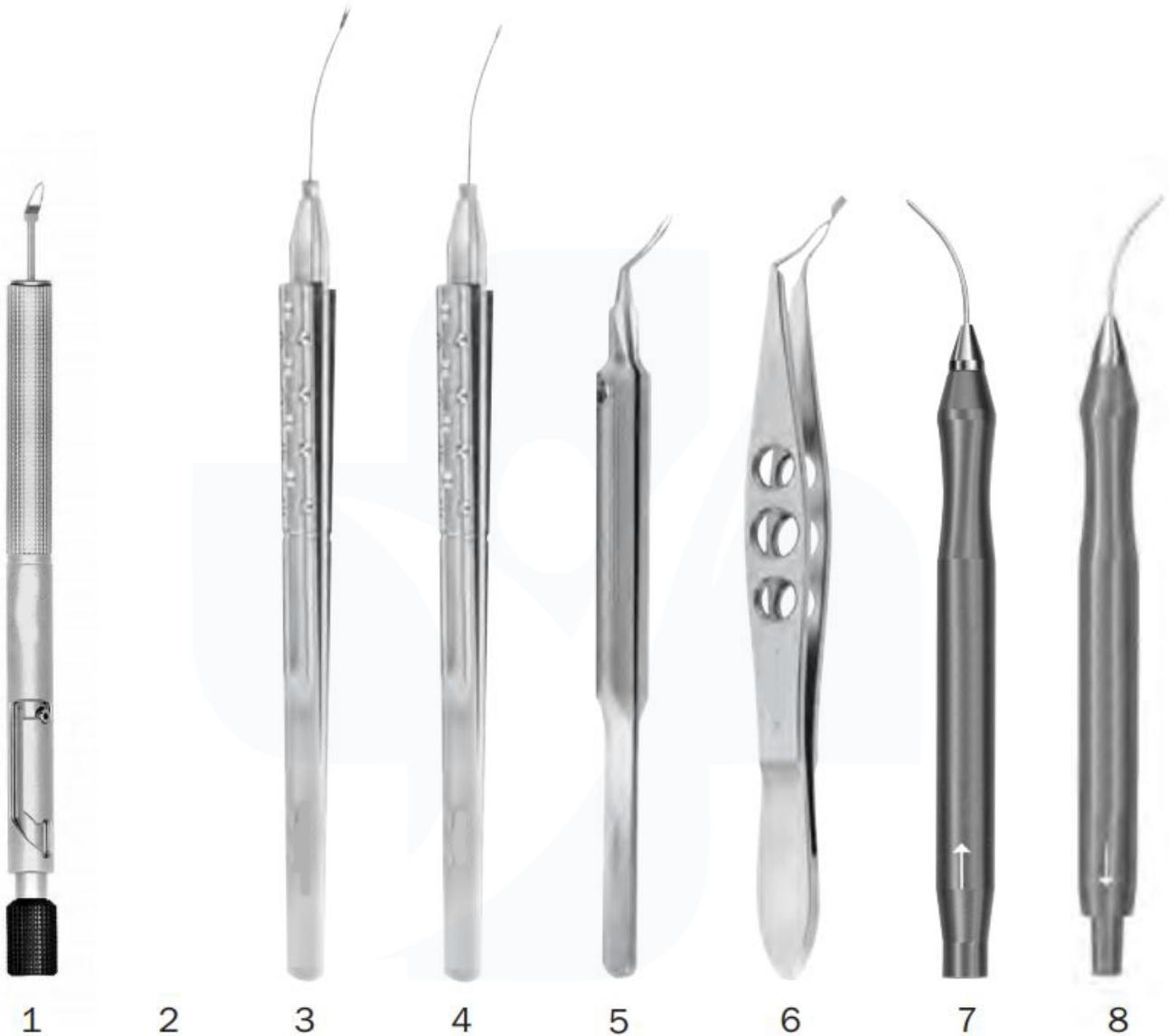

MICRO INCISION CATARACT SURGERY (MICS) SET

1. LT-533 MICS Diamond Knife Trapezoid, 1.8/2.2mm
 2. LT-534 Alio-Kelman IOL Hook
 3. LT-535 Alio MICS Scissors, 23ga.
 4. LT-536 Alio MICS Capsulorrhexis Forceps, 23ga.
 5. LT-537 Giannetti MICS Capsulorrhexis Forceps
 6. LT-538 Ernest Micro Nucleus Cracker
 7. LT-539 Irrigating Handpiece, 23ga., dual 0.3mm ports
 8. LT-540 Aspirating Handpiece, 0.3mm, with textured tip
 9. LT-541 Instrument Case, medium, aluminum
- * not shown



MANUAL PHACOFRACTURE CATARACT EXTRACTION SET

- | | |
|---|--|
| <ol style="list-style-type: none"> 1. LT-542 Lieberman Speculum, V-wire 2. LT-543 Eye Scissors, straight 3. LT-544 Westcott Tenotomy Scissors 4. LT-545 Castroviejo Forceps, 0.12mm 5. K20-546 Chuck Handle (3) 6. K20-547 Performance Lamellar Blade #66 (bx) 7. K20-548 Performance Super Sharp Blade (bx) 8. K20-549 Performance Phaco Blade (bx) 9. LT-550 Castroviejo Caliper, straight 10. LT-551 Utrata Capsulorrhexis Forceps 11. LT-552 Kuglen Lens Manipulator, angled 12. LT-553 Alfonso Cutting Platform, 2mm 13. LT-554 Alfonso Cutting Platform, 3mm 14. LT-555 Alfonso Nucleus Trisector, oval | <ol style="list-style-type: none"> 15. LT-556 Bucher-Kansas Nucleus Trisector 16. LT-557 Kansas Nucleus Bisector 17. LT-558 Alfonso Nucleus Forceps, 3x4 teeth 18. LT-559 Alfonso-McIntyre Irrigating Spoon, small 19. LT-560 Alfonso-McIntyre Irrigating Spoon, large 20. LT-561 McIntyre Infusion Handle 21. LT-562 Air Injection Cannula, 27ga. 22. LT-563 Anis Cortex Aspirating Cannula, straight 23. LT-564 Brierley Chamber Maintainer 24. LT-565 Bipolar Forceps, straight, pointed 25. LT-566 Dodick IOL Folding Forceps 26. LT-567 Buratto Soft IOL Inserter 27. LT-568 Silicone Tubing w/adaptor for LT-6750 28. LT-569 Sterilizing Case, double, plastic |
|---|--|

* not shown



MANUAL SMALL INCISION CATARACT SURGERY (MSICS) SET

1. LT-570 Barraquer Wire Speculum, large
2. LT-571 Wilder Lens Loop, serrated
3. LT-572 Sinskey II Lens Hook, angled
4. LT-573 Barraquer Needle Holder, curved, titanium
5. LT-574 Harms-Colibri Forceps, 0.12mm curved
6. LT-575 Shepard Lens Forceps
7. LT-576 Gaskin Fragment Forceps, angled
8. LT-577 Barraquer Iris Spatula, 0.5mm
9. LT-578 Hartmann Mosquito Forceps, straight
10. LT-579 Vannas Scissors, straight
11. LT-580 Westcott Stitch Scissors
12. LT-581 Strauss-Simcoe I/A Cannula
13. LT-582 Utrata Capsulorrhexis Forceps
14. LT-583 Sterilizing Case, medium, aluminum

* not shown



LIMBAL RELAXING INCISION SET

1. LT-584 LRI Step Knife, 3 Steps (0.5, 0.55, 0.6mm)
2. LT-585 Hu Femto Forceps
3. LT-586 Henderson Alignment Marker
4. LT-587 Alignment Marker with Bubble
5. LT-588 Henderson Degree Gauge
6. LT-589 Henderson Limbal Relaxing Incision Marker
7. LT-590 Chu Limbal Relaxing Incision Marker
8. LT-591 Marking Pen, sterile, disposable (pk/10)
9. LT-592 Instrument Case, small, aluminum
* not shown



TORIC IOL SET

1. LT-593 Henderson Degree Gauge
2. LT-594 Henderson Alignment Marker
3. LT-595 Alignment Marker with Bubble
4. LT-596 Henderson Toric IOL Marker
5. LT-597 Lu Irrigating Toric Lens Manipulator
6. LT-598 Scorsetti-Shepherd Capsule Polisher, 90°
7. LT-599 Henderson MICS Capsule Polisher
8. LT-600 Marking Pen, sterile, disposable (pk/10)
9. LT-601 Sterilizing Case, medium, plastic
* not shown

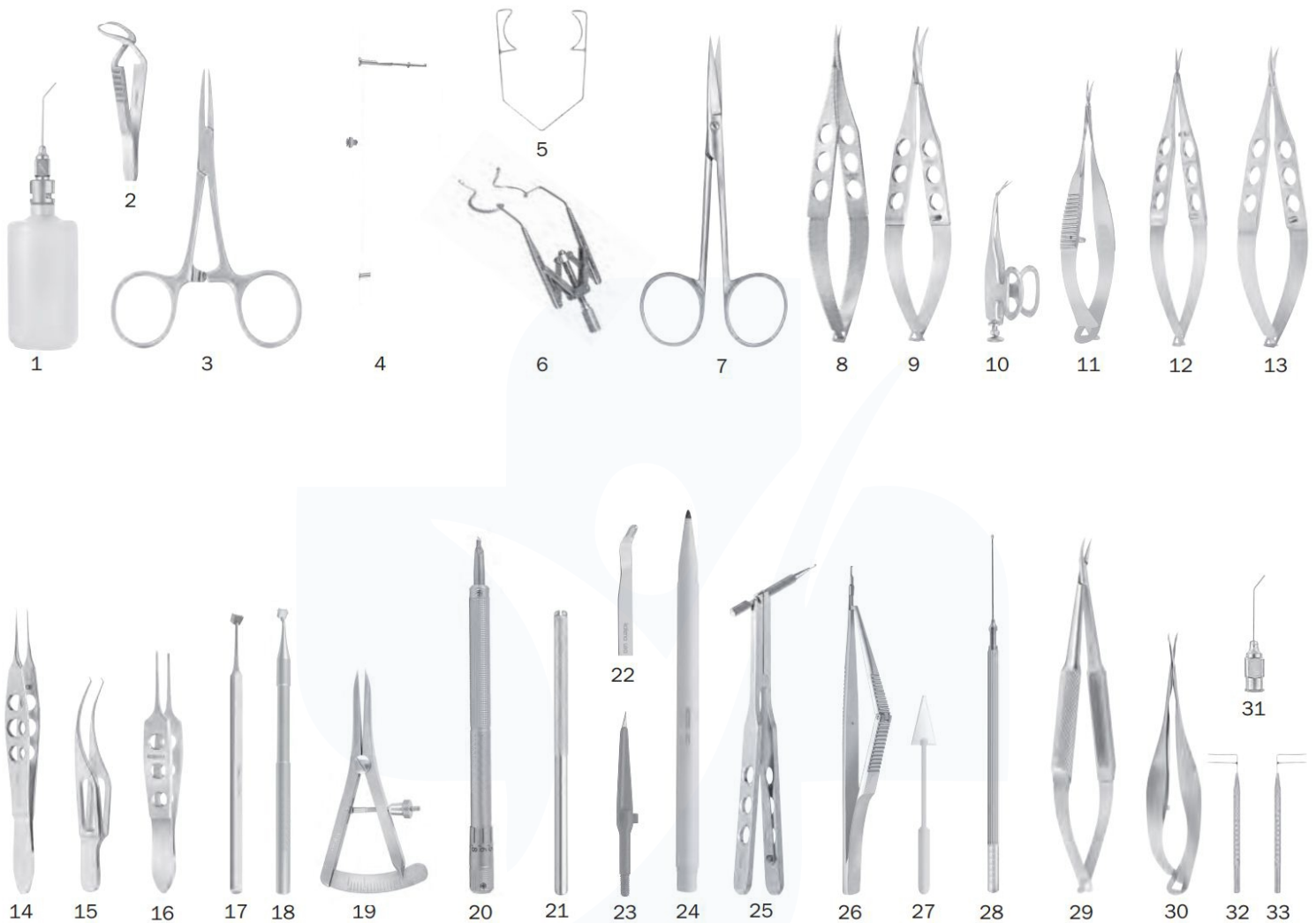

GLAUCOMA SET

- | | |
|--|--|
| <ol style="list-style-type: none"> 1. LT-602 Bishop-Harmon A/C Irrigator 2. LT-603 Jones Towel Clamp 3. LT-604 Hartmann Mosquito Forceps, straight 4. LT-605 Schott Eye Speculum, adjustable 5. LT-606 Barraquer Wire Speculum, large 6. LT-607 Double-X Speculum, 13mm blades 7. LT-608 Eye Scissors, straight 8. LT-609 Sarkisian-Westcott Scissors, small blades 9. LT-610 Westcott Tenotomy Scissors 10. LT-611 Barraquer Iris Scissors 11. LT-612 Mini Westcott Scissors 12. LT-613 Katena-Vannas Scissors, 7mm, curved 13. LT-614 McPherson-Westcott Stitch Scissors 14. LT-615 Fechtner Conjunctiva Forceps (2) 15. LT-616 Colibri Forceps, 0.12mm teeth 16. LT-617 shop-Harmon Forceps 17. LT-618 Fechtner Trabeculectomy Marker 18. LT-619 Fechtner EX-PRESS® Marker 19. LT-620 Castroviejo Caliper, straight 20. LT-621 Diamond Step Knife, 10-facet | <ol style="list-style-type: none"> 21. LT-622 Chuck Handle (2) 22. LT-623 Lamellar Blade #66 (bx) 23. LT-624 Super Sharp Blade, 15 deg. (bx) 24. LT-625 Marking Pen, sterile, disposable (pk/10) 25. LT-626 Luntz-Dodick Trabeculectomy Punch 26. LT-627 Kelly Descemet's Membrane Punch 27. K20-628 K-Sponge Spears 28. LT-629 Blumenthal Conjunctiva Dissector 29. LT-630 Barraquer Needle Holder, curved 30. LT-631 Katena Micro Tying Scissors 31. LT-632 Air Injection Cannula, 27ga. 32. LT-633 Harms Trabeculectomy Probe, right 33. LT-634 Harms Trabeculectomy Probe, left 34. LT-635 Sterilizing Case, double, aluminum
* not show |
|--|--|

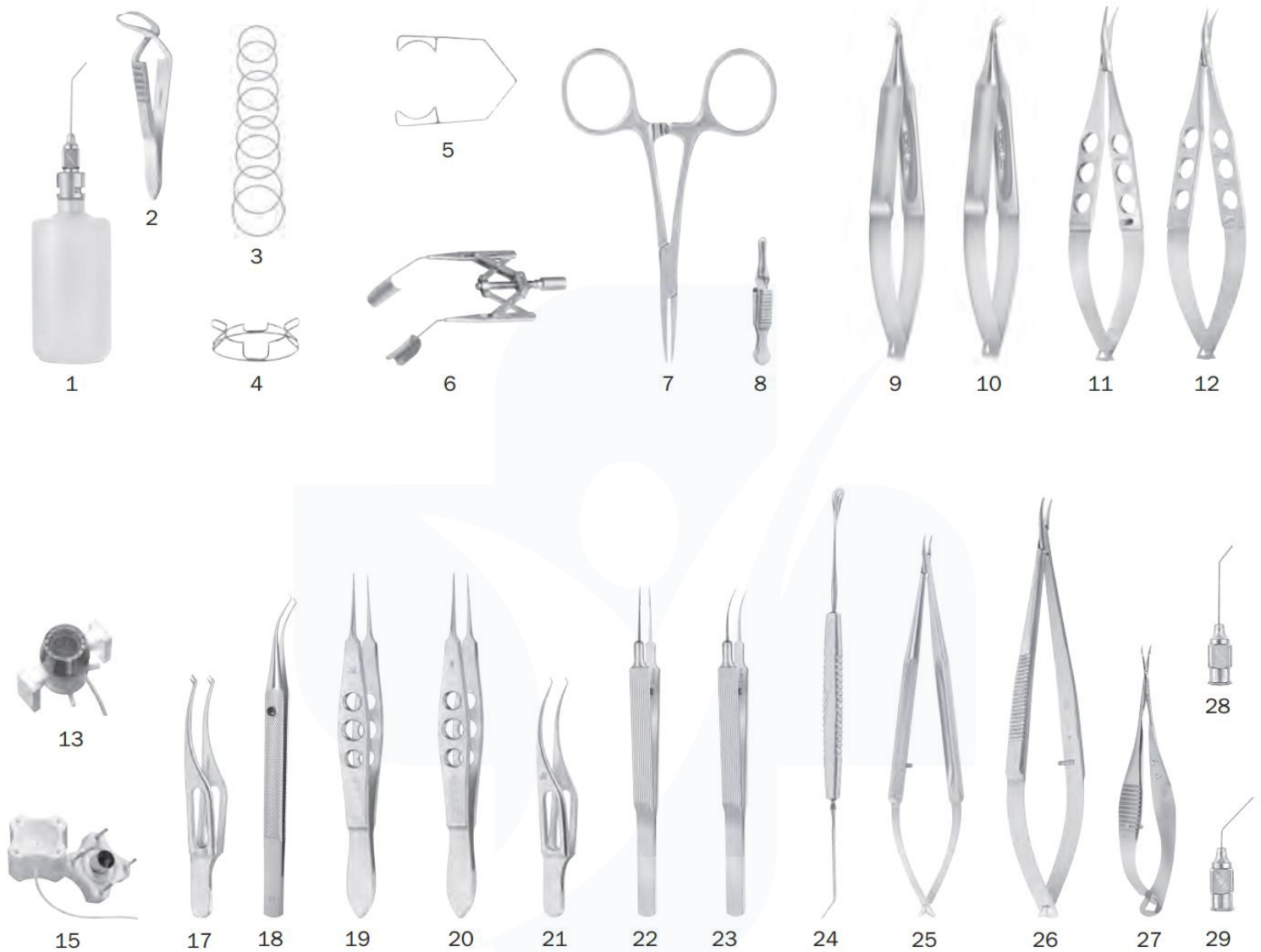

CORNEAL TRANSPLANT SET

1. LT-636 Bishop-Harmon A/C Irrigator
2. LT-637 Jones Towel Clamp
3. LT-638 Flieringa Rings (set of 8)
4. LT-639 McNeill-Goldman Fixation Ring
5. LT-640 Barraquer Wire Speculum, large
6. LT-641 Double-X Speculum, solid blade 15mm
7. LT-642 Hartmann Mosquito Forceps, straight (2)
8. LT-643 Serrefine, small, straight (2)
9. LT-644 Terry Micro Corneal Scissors, left
10. LT-645 Terry Micro Corneal Scissors, right
11. LT-646 Westcott Tenotomy Scissors
12. LT-647 Jaffe Stitch Scissors
13. LT-648 Barron Vacuum Trepphine, 7.5mm
14. LT-649 Barron Vacuum Trepphine, 8.0mm
15. LT-650 Barron Vacuum Punch, 8.0mm
16. LT-651 Barron Vacuum Punch, 8.5mm
17. LT-652 Polack Double Corneal Fixation Forceps
18. LT-653 Perl Corneal Forceps, 0.08mm, left
19. LT-654 Castroviejo Forceps, 0.12mm
20. LT-655 Castroviejo Forceps, 0.3mm
21. LT-656 Harms-Colibri Forceps, 0.12mm
22. LT-657 Tennant Tying Forceps, straight
23. LT-658 Tennant Tying Forceps, curved
24. LT-659 Paton Spatula & Spoon
25. LT-660 Katena Needle Holder, curved w/lock
26. LT-661 Castroviejo Needle Holder, curved w/lock
27. LT-662 Katena Micro Tying Scissors
28. LT-663 Air Injection Cannula, 30ga.
29. LT-664 McIntyre A/C Cannula, 26ga.
30. LT-665 Sterilizing Case, double, aluminum
31. LT-666 K-Sponge II spears, synthetic (bx)
*not shown

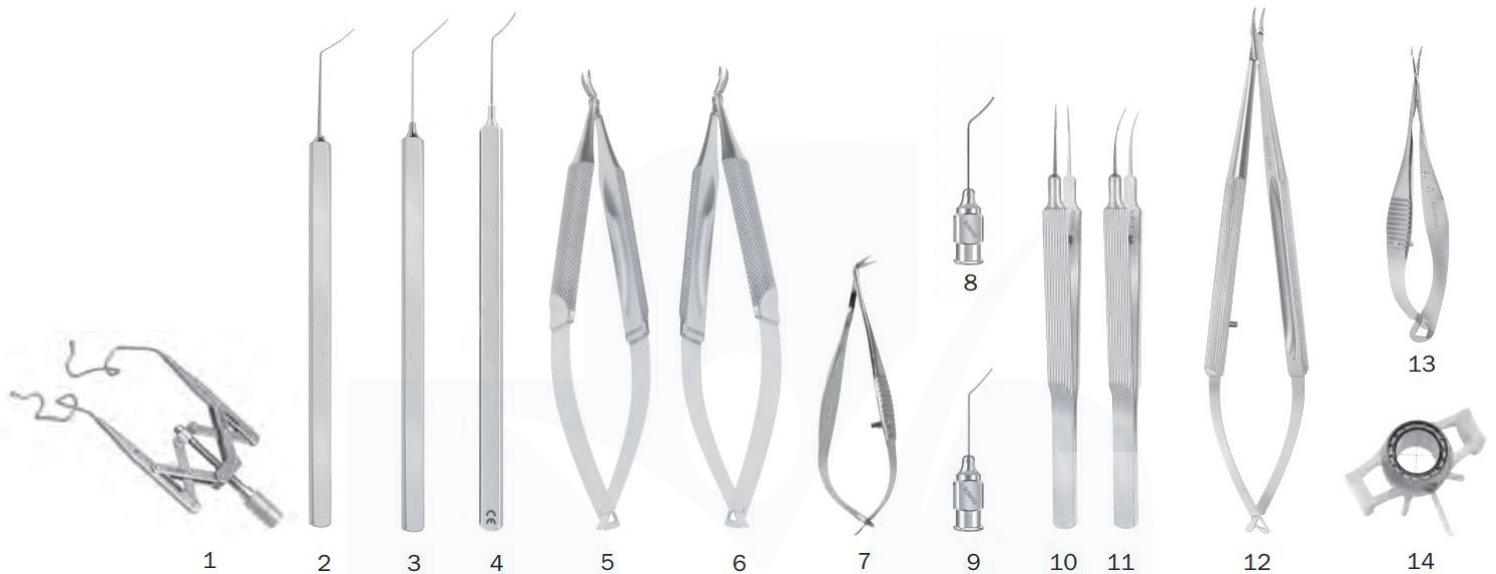

DEEP ANTERIOR LAMELLAR KERATOPLASTY(DALK) SET

1. LT-667 Double-X Speculum, K-Wire, 15mm blades
2. LT-668 DALK Corneal Dissector
3. LT-669 Rosenwasser DALK Trisector
4. LT-670 Bonfadini DALK Spatula
5. LT-671 Holland DALK Scissors, left
6. LT-672 Holland DALK Scissors, right
7. LT-673 Holland DALK Scissors, angled, blunt
8. LT-674 DALK Air Injection Cannula, 27ga.
9. LT-675 Rosenwasser DALK Cannula, 27ga.
10. LT-676 Tennant Tying Forceps, delicate, straight
11. LT-677 Tennant Tying Forceps, delicate, curved
12. LT-678 Katena Needle Holder, extra-delicate, curved
13. LT-679 Katena Micro Tying Scissors
14. LT-680 Barron Radial Vacuum Trephine, 8.0mm
15. LT-681 Sterilizing Case, medium, aluminum
*not shown



ENDOTHELIAL TRANSPLANTATION SET

- | | |
|---|---|
| <ol style="list-style-type: none"> 1. LT-682 Double-X Speculum, 13mm blades 2. LT-683 Corneal Dissector, straight 3. LT-684 Corneal Dissector, vaulted 4. LT-685 Reversed Sinsky Hook 5. LT-686 Endothelial Stripper 6. LT-687 Rosenwasser Irrigating Endothelial Stripper 7. LT-688 Florakis Endothelial Forceps 8. LT-689 Bores Optic Zone Marker, 9.0mm 9. LT-690 Rosenwasser Donor Lamellar Inserting Shovel 10. LT-691 Rosenwasser Donor Lamella Inserting Forceps 11. LT-692 Endothelial Glide Spatula | <ol style="list-style-type: none"> 12. LT-693 DSEK Grasping Forceps, 23ga. 13. LT-694 Rootman-Goldich DMEK Dissector 14. LT-695 Rubenstein Corneal Roller, sterile (pk/3) 15. LT-696 Dahan-Blumenthal A/C Maintainer 16. LT-697 Barron Vacuum Punch, 8.5mm 17. LT-698 Barron Vacuum Punch, 8.75mm 18. LT-699 Barron Vacuum Punch, 9.0mm 19. LT-700 Barron Vacuum Punch, 9.5mm 20. LT-701 Barron Artificial Anterior Chamber 21. 702 Barron Stainless Steel Base 22. LT-703 Instrument Case, large, aluminum
*not shown |
|---|---|

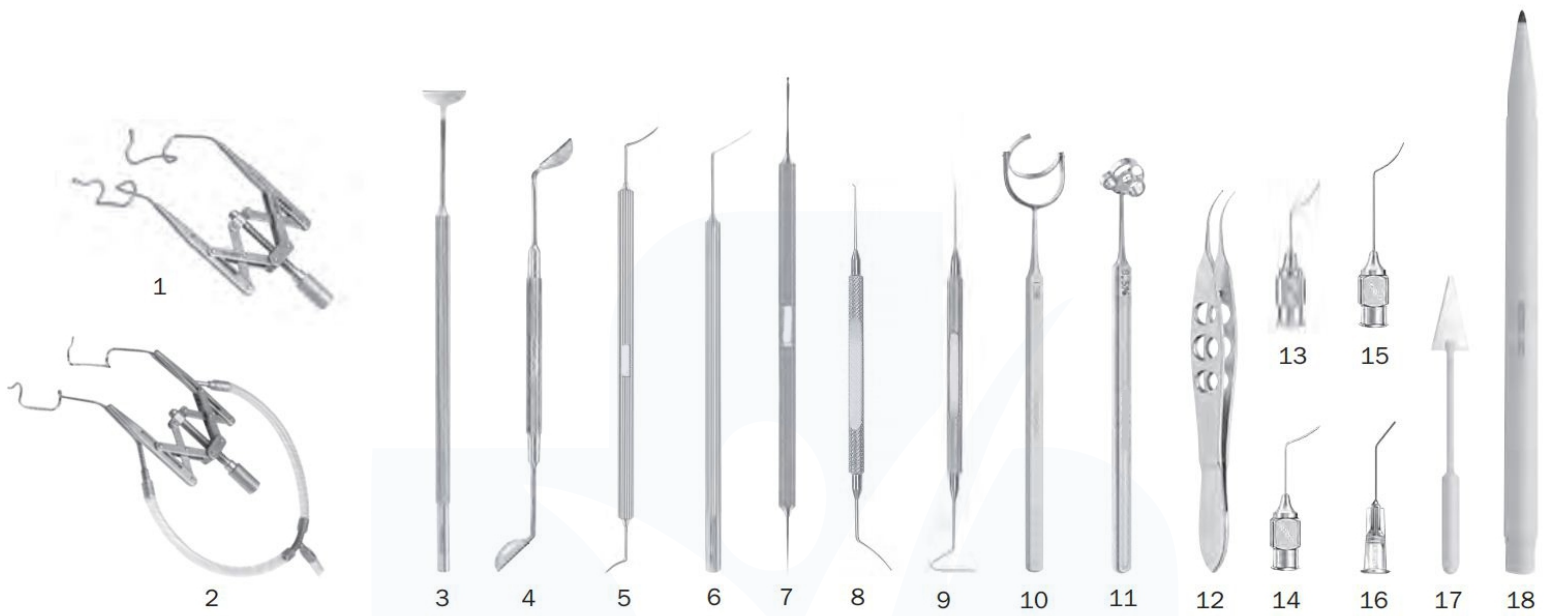

LASIK SET

1. LT-704 Double-X Speculum, K-Wire, 15mm blades
 2. LT-705 Double-X Aspirating Speculum (optional)
 3. LT-706 Buratto Flap Protector
 4. LT-707 Mannis-Buratto Flap Protector
 5. LT-708 Hersh LASIK Spatula
 6. LT-709 Fukasaku LASIK Spatula
 7. LT-710 Katzen LASIK Flap Unzipper
 8. LT-711 Thorlakson Z-LASIK™ Flap Lifter
 9. LT-712 IntraLase® Flap Lifter, D-E
 10. LT-713 Gimbel Stabilization Ring
 11. LT-714 Chayet Corneal Marker
 12. LT-715 Buratto LASIK Flap Forceps
 13. LT-716 Banaji LASIK Cannula, 26ga.
 14. LT-717 Spatulated LASIK Cannula, 26ga.
 15. LT-718 Buratto LASIK Cannula, 3-ports, 23ga.
 16. LT-719 John IntraLasik Cannula, sterile (pk/10)
 17. LT-720 K-Sponge II spears, synthetic (bx)
 18. LT-721 Marking Pen, standard (pk/10)
 19. LT-722 Instrument Case, large, aluminum
- *not shown



FEMTOSECOND LASIK SET

1. LT-723 Double-X Aspirating Speculum
2. LT-724 Double-X Speculum, K-Wire, 15mm blades
3. LT-725 Buratto LASIK Flap Protector
4. LT-726 Thorlakson Z-LASIK™ Flap Lifter, short handle
5. LT-727 IntraLase® Flap Lifter, D-E
6. LT-728 Dulaney Corneal Marker
7. LT-729 Buratto LASIK Flap Forceps
8. LT-730 Buratto LASIK Cannula, 23ga.
9. LT-731 K-Sponge II Spears, synthetic (bx)
10. LT-732 Instrument Case, small, aluminum
*not shown

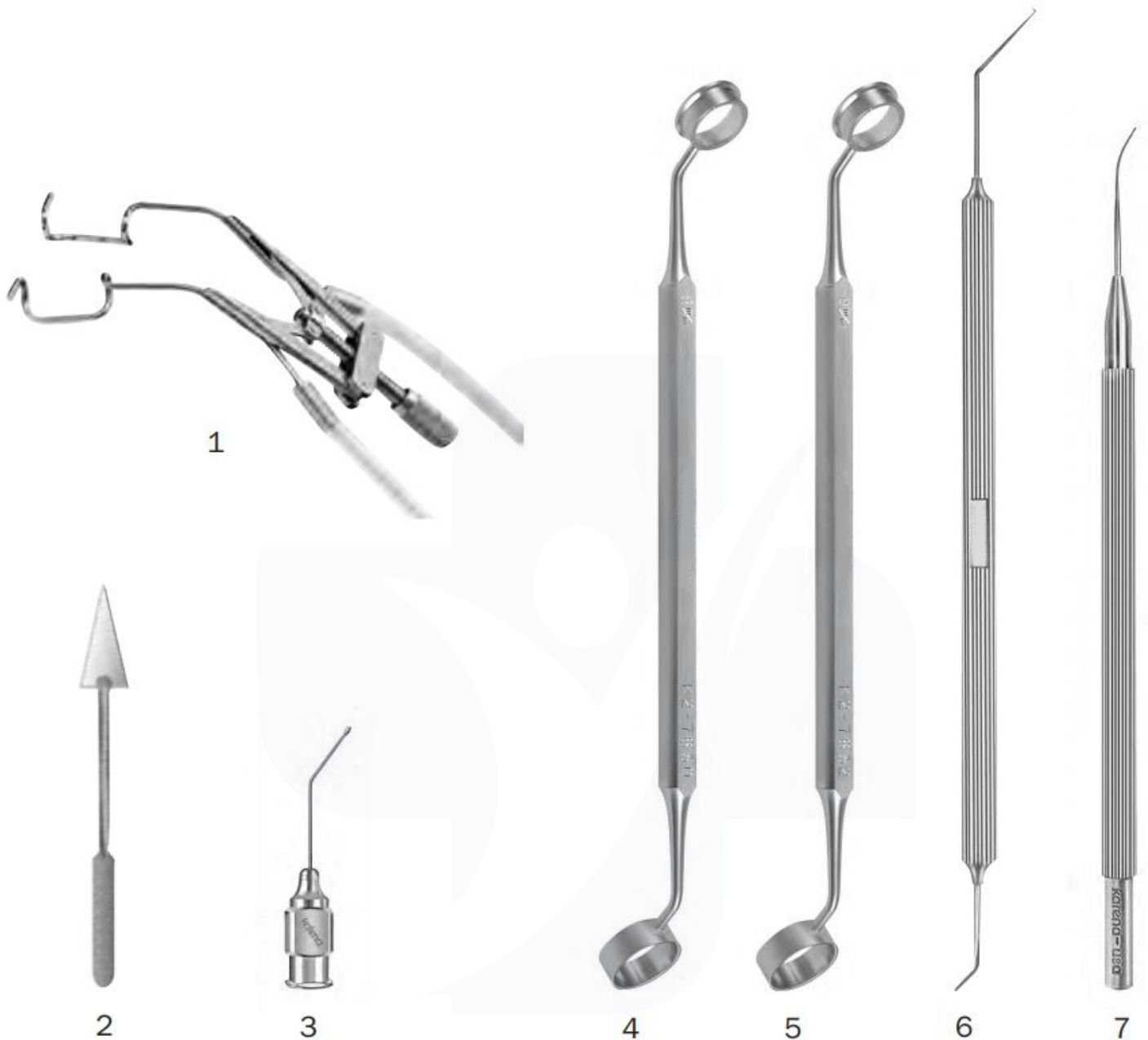

LASEK SET

1. LT-733 Lieberman Aspirating Speculum
2. LT-734 K-Sponge II, synthetic (bx)
3. LT-735 Alcohol Cannula
4. LT-736 Trepine & Well 8/8.5mm
5. LT-737 Trepine & Well 9/9.5mm
6. LT-738 Micro-Hoe & Epi-Peeler
7. LT-739 Flap Repositor
8. LT-740 Instrument Case, small, aluminum



LID SET

- | | |
|---|---|
| <ol style="list-style-type: none"> 1. LT-741 Bishop-Harmon A/C Irrigator 2. LT-742 Jones Towel Clamp, 2 1/4" 3. LT-743 Halsted Mosquito Forceps, curved (2) 4. LT-744 Halsted Mosquito Forceps, straight 5. LT-745 Stevens Scissors, straight 6. LT-746 Eye Scissors, straight 7. LT-747 Chuck Handle 9. LT-748 Westcott Tenotomy Scissors 10. LT-749 Westcott Stitch Scissors 11. LT-750 Berke Ptosis Forceps 12. LT-751 Ptosis Lid Clamp, 6-pin, concave 13. LT-752 Barraquer Needle Holder, curved 14. LT-754 Jaeger Lid Plate, stainless steel 15. LT-755 Castroviejo Needle Holder, curved 16. LT-756 Castroviejo Caliper, straight 17. LT-757 Desmarres Lid Retractor #1 18. LT-758 Desmarres Lid Retractor #2 | <ol style="list-style-type: none"> 19. LT-759 Desmarres Lid Retractor #3 20. LT-760 Graefe Muscle Hook #2 21. LT-761 Fixation Hook, double 22. LT-762 Arita Meibomian Gland Compressor 23. LT-763 Bonaccolto Conjunctiva Forceps 24. LT-764 Bishop-Harmon Forceps 25. LT-765 Castroviejo Forceps, 0.3mm 26. LT-766 Helveston Tying Forceps 27. LT-767 Downes Lid Clamp 28. LT-768 Bipolar Forceps, angled, blunt 29. LT-769 Bipolar Cord 30. LT-770 Scleral Shield, small, pair 31. LT-771 Scleral Shield, large, pair 32. LT-772 Helveston Retractor, concave, 11mm 33. LT-773 Knapp Retractor, 4-prong 34. LT-774 Marking Pen, (pk/10) 35. LT-775 Sterilizing Case, double, aluminum |
|---|---|

* not show



VETERINARY OPHTHALMIC SET

LT-776 Barraquer Wire Speculum, small
 LT-777 Barraquer Wire Speculum, large
 LT-778 Iris Forceps
 LT-779 Colibri Forceps, 1x2 teeth, 0.4mm
 LT-780 Harms-Colibri Forceps, 0.12mm
 LT-781 Castroviejo Corneal Scissors, small, right
 LT-782 Castroviejo Corneal Scissors, small, left
 LT-783 Westcott Tenotomy Scissors
 LT-784 Utrata Capsulorrhexis Forceps
 LT-785 Bishop-Harmon Forceps
 LT-786 Dressing Forceps, delicate, straight
 LT-787 Tissue Forceps, delicate, straight
 LT-788 Chang Phaco Chopper
 LT-789 Warren Canine Phaco Chopper
 LT-790 Intraocular Scissors, straight
 LT-791 Intraocular Scissors, angled 30°

LT-792 Adson Tissue Forceps
 LT-793 Castroviejo Needle Holder, curved, w/lock
 LT-794 Castroviejo Needle Holder, heavy, curved
 LT-795 Sinskey Lens Hook, angled
 LT-796 Jaffe-Bechert Rotator, 9mm
 LT-797 Chuck Handle (2)
 LT-798 Bard-Parker Handle
 LT-799 Jones Towel Clamp (4)
 LT-800 Halsted Mosquito Forceps, straight (2)
 LT-801 Halsted Mosquito Forceps, curved (2)
 LT-802 Metzenbaum Dissecting Scissors
 LT-803 Chang Hydrodissection Cannula
 LT-804 Instrument Case, double, aluminum



LOTUSMED
INSTRUMENTS



Lotus Instruments



+92-317-7290854



www.lotusmedinstruments.com



lotusmedinstrument@gmail.com